

# **Agilent Technologies N5281A**

## **User's and Service Guide**

**Use this manual with the following document:  
Network Analyzer On-line Help System**



**Agilent Technologies**

**Manufacturing Part Number: N5281-90001**

**Printed in USA: May 2010**

**Supersede February 2010**

© Copyright 2009, 2010 Agilent Technologies, Inc. All rights reserved.

---

## Warranty Statement

THE MATERIAL CONTAINED IN THIS DOCUMENT IS PROVIDED “AS IS,” AND IS SUBJECT TO BEING CHANGED, WITHOUT NOTICE, IN FUTURE EDITIONS. FURTHER, TO THE MAXIMUM EXTENT PERMITTED BY APPLICABLE LAW, AGILENT DISCLAIMS ALL WARRANTIES, EITHER EXPRESS OR IMPLIED WITH REGARD TO THIS MANUAL AND ANY INFORMATION CONTAINED HEREIN, INCLUDING BUT NOT LIMITED TO THE IMPLIED WARRANTIES OF MERCHANTABILITY AND FITNESS FOR A PARTICULAR PURPOSE. AGILENT SHALL NOT BE LIABLE FOR ERRORS OR FOR INCIDENTAL OR CONSEQUENTIAL DAMAGES IN CONNECTION WITH THE FURNISHING, USE, OR PERFORMANCE OF THIS DOCUMENT OR ANY INFORMATION CONTAINED HEREIN. SHOULD AGILENT AND THE USER HAVE A SEPARATE WRITTEN AGREEMENT WITH WARRANTY TERMS COVERING THE MATERIAL IN THIS DOCUMENT THAT CONFLICT WITH THESE TERMS, THE WARRANTY TERMS IN THE SEPARATE AGREEMENT WILL CONTROL.

---

## DFARS/Restricted Rights Notice

If software is for use in the performance of a U.S. Government prime contract or subcontract, Software is delivered and licensed as “Commercial computer software” as defined in DFAR 252.227-7014 (June 1995), or as a “commercial item” as defined in FAR 2.101(a) or as “Restricted computer software” as defined in FAR 52.227-19 (June 1987) or any equivalent agency regulation or contract clause. Use, duplication or disclosure of Software is subject to Agilent Technologies’ standard commercial license terms, and non-DOD Departments and Agencies of the U.S. Government will receive no greater than Restricted Rights as defined in FAR 52.227-19(c)(1-2) (June 1987). U.S. Government users will receive no greater than Limited Rights as defined in FAR 52.227-14 (June 1987) or DFAR 252.227-7015 (b)(2) (November 1995), as applicable in any technical data.

---

## Safety Notes

The following safety notes are used throughout this document. Familiarize yourself with each of these notes and its meaning before performing any of the procedures in this document.

---

**WARNING**      **Warning denotes a hazard. It calls attention to a procedure which, if not correctly performed or adhered to, could result in injury or loss of life. Do not proceed beyond a warning note until the indicated conditions are fully understood and met.**

---

---

**CAUTION**      Caution denotes a hazard. It calls attention to a procedure that, if not correctly performed or adhered to, could result in damage to or destruction of the instrument. Do not proceed beyond a caution sign until the indicated conditions are fully understood and met.

---

---

## Definitions

- *Specifications* describe the performance of parameters covered by the product warranty (temperature –0 to 55 °C, unless otherwise noted.)
- *Typical* describes additional product performance information that is not covered by the product warranty. It is performance beyond specification that 80% of the units exhibit with a 95% confidence level over the temperature range 20 to 30 °C. Typical performance does not include measurement uncertainty.
- *Nominal* values indicate expected performance or describe product performance that is useful in the application of the product, but is not covered by the product warranty.
- *Characteristic Performance* describes performance parameter that the product is expected to meet before it leaves the factory, but is not verified in the field and is not covered by the product warranty. A characteristic includes the same guard bands as a specification.



---

# Contents

## N5281A

Introduction	2
Description	5
Network Analyzer Requirements	5
Available Options	7
Test Set Options	7
Verifying the Shipment	7
General Specifications	8
Power Requirements	9
Environmental Requirements	10
Environmental Tests	10
Equipment Heating and Cooling	10
Required Conditions for Accuracy Enhanced Measurement	10
Dimensions and Space Requirements	11
Maximum Power Levels	12
Front and Rear Panel Features	13
RF Input (A, B, C and D)	13
Line Switch	13
IF OUT (A, B, C/R1 and D/R2)	14
LO IN	14
Attenuators (A, B, C and D)	14
Line Module	14
Available Fuses	15
Controlling the Test Set with E8363B/C or E8364B/C	16
Controlling the Test Set with N5264A	18
Controlling the Test Set with N5244A or N5245A	22
Controlling the RF Receiver Attenuators	24
Operational Check	26
Equipment Required	26
Verification Limits	27
E8364B/C Operational Check Procedure	30
Preparing the E8364B/C	30
N5245A Operational Check Procedure	33
Preparing the N5245A	33
Attenuator Element Verification Procedure	36
Service Information	39
Replaceable Parts	40
Safety and Regulatory Information	45
Introduction	45
Before Applying Power	45
Connector Care and Cleaning	45
Declaration of Conformity	45
Statement of Compliance	45
Shipping Your Analyzer to Agilent for Service or Repair	46
Battery Collection	46
Compliance with German Noise Requirements	46
EMC Information	46
Warnings	47
Cautions	48
Instrument Markings	49
Electrostatic Discharge Protection	50
Contacting Agilent Sales and Service Offices	51

---

# Contents

---

# **N5281A**

---

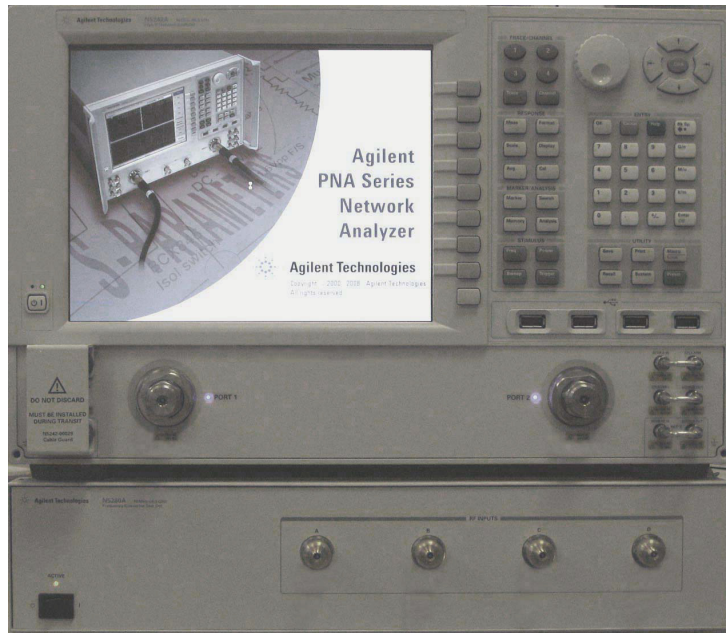
## Introduction

The N5281A replaces the Hewlett Packard 8511B Four Channel Frequency Converter Test Set. This document describes how to use the N5281A Test Set with the following instruments.

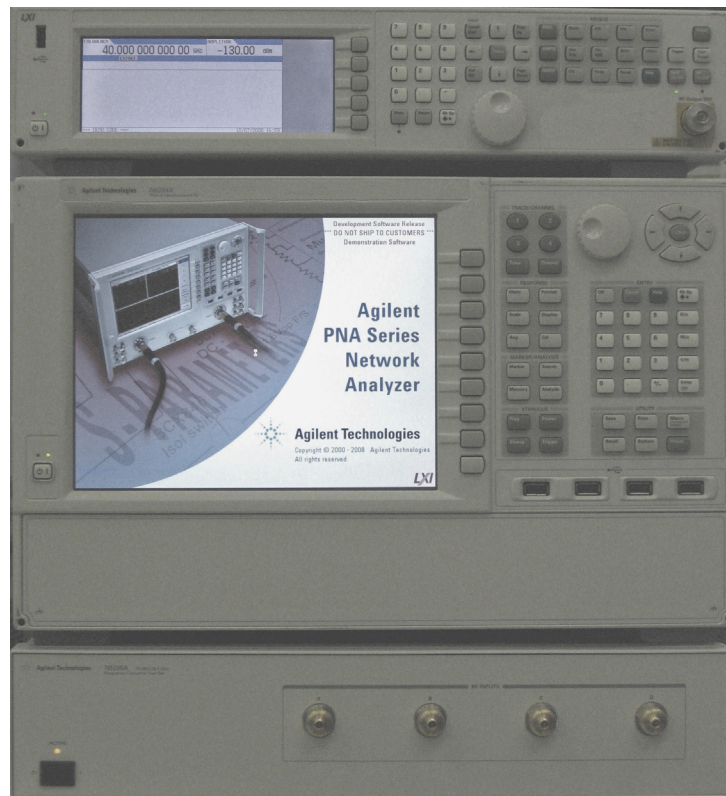
- E8363B/C (10 MHz to 40 GHz) PNA Network Analyzer
- E8364B/C (10 MHz to 50 GHz) PNA Network Analyzer
- N5244A (10 MHz to 40 GHz) PNA-X Network Analyzer
- N5245A (10 MHz to 50 GHz) PNA-X Network Analyzer
- N5264A PNA-X Measurement Receiver



**Figure 1 E8364B/C with N5281A**



**Figure 2 N5264A Measurement Receiver with N5281A**



**Figure 3 N5244/45A (2-Port) with N5281A**



**Figure 4 N5244/45A (4-Port) with N5281A**



---

## Description

The Agilent N5281A is a four channel frequency converter test set. This test set is used with the Agilent E8363B/C (10 MHz to 40 GHz), E8364B/C (10 MHz to 50 GHz) PNA Network Analyzers, N5244A (10 MHz to 40 GHz), N5245A (10 MHz to 50 GHz) PNA-X Network Analyzers, and the N5264A PNA-X Measurement Receiver. The N5281A provides a convenient means of customizing a test configuration for a variety of applications within a frequency range of 10 MHz to 50 GHz. In addition to configurations for measuring reflection and transmission parameters of 1-port or 2-port devices, you can build configurations to characterize antenna parameters, radar cross sections and frequency translation devices. [Figure 5 on page 6](#) illustrates one possible measurement set-up configuration.

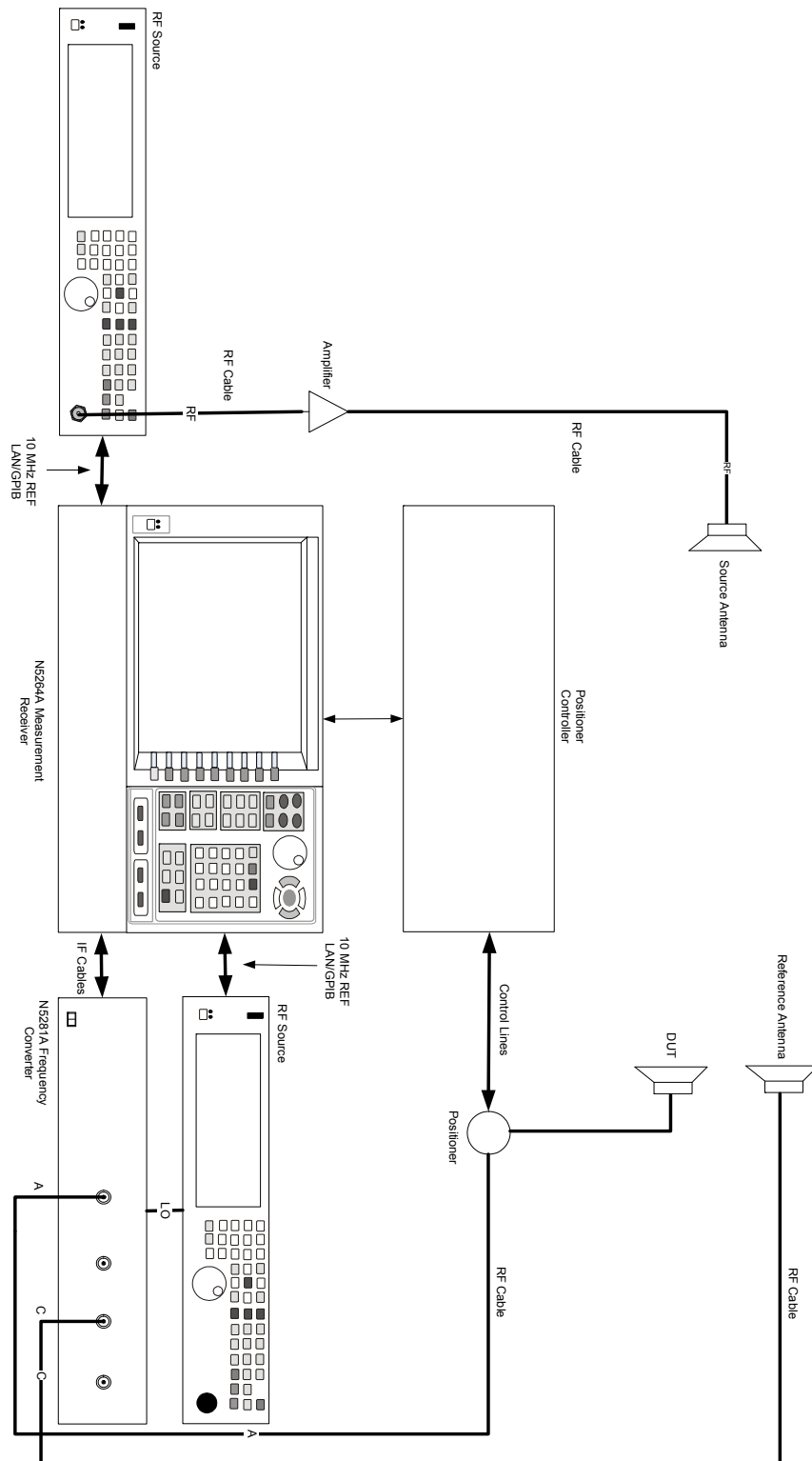
## Network Analyzer Requirements

- The E8363B/C 2-Port, 4 Receiver, Vector Network Analyzer (10 MHz to 40 GHz) requires Option H11, which adds IF access.
- The E8364B/C 2-Port, 4 Receiver, Vector Network Analyzer (10 MHz to 50 GHz) requires Option H11, which adds IF access.
- The N5244A Microwave Network Analyzer (10 MHz to 40 GHz) requires Option 020, which adds external IF Inputs.
- The N5245A Microwave Network Analyzer (10 MHz to 50 GHz) requires Option 020, which adds external IF Inputs.

More Network Analyzer information is available on the following websites:

- Documentation - <http://www.agilent.com/find/pna>
- Network Analyzer Firmware - <http://na.tm.agilent.com/pna/firmware/firmware.htm>

Figure 5 Measurement Setup



---

## Available Options

### Test Set Options

The N5281A has two available test set options:  
Refer to [Figure 32 on page 41](#) and [Figure 33 on page 42](#).

- Standard - There are no attenuators in the RF Input paths.
- Option 001 - There are four 35 dB attenuators in RF Input paths to reduce the power levels.

---

## Verifying the Shipment

Inspect the shipping container. If the container or packing material is damaged, it should be kept until the contents of the shipment have been checked mechanically and electrically. If there is physical damage refer to [“Contacting Agilent Sales and Service Offices” on page 51](#). Keep the damaged shipping materials (if any) for inspection by the carrier and an Agilent Technologies representative.

[Table 1](#) contains the accessories shipped with your N5281A.

**Table 1 Content List**

Agilent Part Number	Description	Qty
9320-6636	Functional Test Certificate	1
9320-0333	Envelope-Cal Certificate	1
5063-9232	Rack Mount Kit with Handles	1
5063-9226	Front Handle Kit	1
5061-9038	Cable Assembly	5
1250-2015	Adapter, straight SMA (f) to BNC (m)	4
N5281-90001	User's and Service Guide	1

---

## General Specifications

Specifications for the N5281A Frequency Converter Test Set (10 MHz to 50 GHz) are characteristic for the system performance of the PNA and test set. Actual performance of the system is based on the customers PNA that is used with the test set. A functional certificate is only offered for the N5281A.

A functional certificate is supplied for the N5281A. The N5281A performance is based on external components such as the calibration kit, network analyzer, external sources, and measurement receiver. There are no internal adjustments in the N5281A, therefore an annual calibration is not required.

Frequency range and connectors are listed in [Table 2](#) for specific ports.

**Table 2 Frequency Range and Connectors**

Port	Frequency Range	Connectors
RF Port	0.01 to 50 GHz	2.4 mm female
LO Port	0.01 to 26.5 GHz	3.5 mm female
IF Port	7 MHz	SMA female

## Power Requirements

Verify that the required ac power is available before installing the test set to the network analyzer.

- 100/120/220/240 V (50/60 Hz)
- Air conditioning equipment (or other motor-operated equipment) should not be placed on the same ac line that powers the test set and PNA.
- [Table 3](#) contains the maximum wattage for all instruments. This table can be use to determine the electrical and cooling requirements.

**Table 3 Power Requirements**

Standard Equipment	
Instrument	Maximum Wattage
E8363B/C	350
E8364B/C	350
N5244A	450
N5245A	450
N5264A	450
N5281A	350

---

**WARNING** This is a Safety Class I product (provided with a protective earthing ground incorporated in the power cord). The mains plug shall be inserted only into a socket outlet provided with a protective earth contact. Any interruption of the protective conductor, inside or outside the instrument, is likely to make the instrument dangerous. Intentional interruption is prohibited.

---

## Environmental Requirements

The environmental requirements of the test set are listed in [Table 4](#). Refer to the E8363B/C, E8364B/C, N5244/45A and N5264A User's Guide for environmental specifications.

---

**CAUTION**      Ventilation Requirements: When installing the instrument in a cabinet, the convection into and out of the instrument must not be restricted. The ambient temperature (outside the cabinet) must be less than the maximum operating temperature of the instrument by 4 °C for every 100 watts dissipated in the cabinet. If the total power dissipated in the cabinet is greater than 800 watts, forced convection must be used.

---

**Table 4 N5281A Operating Environment**

Temperature	
Measurement Calibration	20 °C to 26 °C (68 °F to 79 °F)
Performance Verification	Temperature must be within 1 °C (1.8 °F) of the temperature at which the measurement calibration was performed.
Pressure Altitude (Operation or Storage)	0 to 3,000 meters (~10,000 feet)

### Environmental Tests

The N5281A complies with all applicable safety and regulatory requirements for the intended location of use.

### Equipment Heating and Cooling

If necessary, install air conditioning and heating to maintain the ambient temperature within the appropriate range. Air conditioning capacity must be consistent with the BTU ratings given in [Table 3](#).

### Required Conditions for Accuracy Enhanced Measurement

Accuracy-enhanced (error-corrected) measurements require the ambient temperature of the PNA and test set to be maintained within  $\pm 1$  °C of the ambient temperature at calibration.



## Dimensions and Space Requirements

Standard installation of the N5281A and network analyzers includes configuration and installation on a customer provided lab bench, or table top of adequate size and strength.

**Table 5 Instrument Dimensions**

Model	Weight	Height	Width	Depth
E8363B/C	29 kg (64 lb, $\pm 0.5$ lb)	26.7 cm (10.5 in)	43.43 cm (17.10 in)	46.99 cm (18.50 in)
E8364B/C	29 kg (64 lb, $\pm 0.5$ lb)	26.7 cm (10.5 in)	43.43 cm (17.10 in)	46.99 cm (18.50 in)
N5244/45A	See <a href="#">Table 6</a> .	26.7 cm (10.5 in)	42.5 cm (16.8 in)	58.2 cm (22.9 in)
N5264A	22 kg (48 lb, $\pm 0.5$ lb)	26.7 cm (10.5 in)	42.5 cm (16.75 in)	55.8 cm (21.97 in)
N5281A	9.1 kg (20 lb)	8.9 cm (3.5 in)	42.5 cm (16.75 in)	48.3 cm (19 in)

**Table 6 Net Weight**

Weight		
Model	2-Port Modules (Option 200, or 219 or 224)	4-Port Modules (Option 400, or 419 or 423)
N5244/45A	39.1 Kg (86 lb) nominal	41.8 Kg (92 lb) nominal

## Maximum Power Levels

**Table 6 Power Levels**

<b>RF Input Power Damage Levels:</b>	
RF Port	+18 dBm
LO Port	+5 dBm
Optimum LO Power	0 dBm ( $\pm 1$ dB)
<b>RF Input @ 0.1 dB Typical Compression:</b>	
10 MHz to 50 GHz	-10 dBm
<b>IF Output Level<sup>1</sup></b>	
10 MHz to 26.5 GHz	5 dB to -10 dB
26.5 GHz to 50 GHz <sup>2</sup>	-10 dB to -20 dB

1. IF Output level is based on the RF Input @ 0.1 dB typical compression.
2. 3<sup>rd</sup> Harmonic mode.

---

**NOTE** Refer to your PNA specifications to determine the maximum input power levels for the PNA access and test ports, or to optimize the power levels in the receivers.

---



---

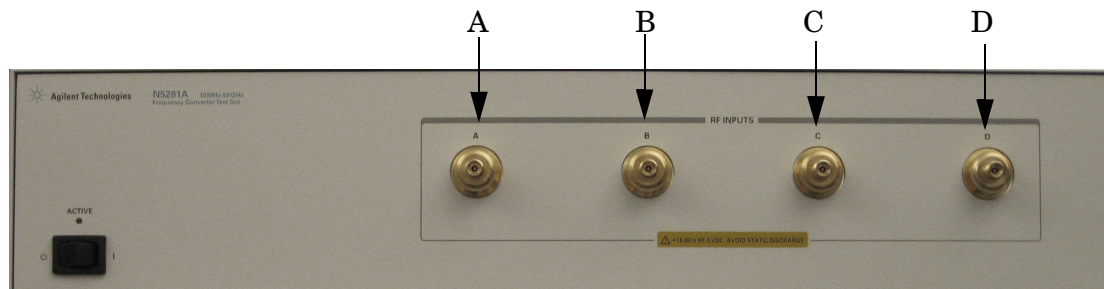
**NOTE** Damage and maximum levels are not necessarily the optimum level.

---

---

## Front and Rear Panel Features

**Figure 7 Front Panel**




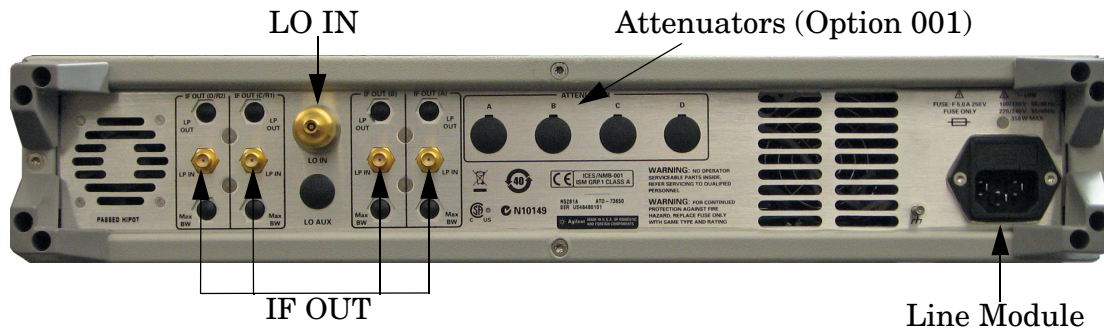
### RF Input (A, B, C and D)

These input ports transmit RF energy to the sampler within the instrument.

### Line Switch

This switch turns the test set on and off.

-  – Standby
- | – ON (Active LED On)

**Figure 8 Rear Panel (Multiport Test Set)**

### IF OUT (A, B, C/R1 and D/R2)

The IF Outputs are connected to the IF Inputs on the PNA. These connectors transmit the IF signal from the test set to the E8363B/C, E8364B/C, N5244A, N5245A and N5264A.

### LO IN

LO IN is connected to the LO from the TEST SET DRIVERS on the network analyzer.

### Attenuators (A, B, C and D)

These connectors are used only in test sets with Option 001. The four Viking attenuator connectors are controlled by the 11713C Attenuator Switch Driver.

### Line Module

The line fuse, as well as a spare, reside within the line module. [Figure 9](#) illustrates where the fuses are located and how to access them.

## Available Fuses

- Fuse (F 5 A/250V, 2110-0709) UL listed and CSA certified.

---

**CAUTION** Verify that the premise electrical voltage supply is within the range specified on the instrument.

---

**Figure 9** Line Fuse



---

**CAUTION** This instrument has autoranging line voltage input; be sure the supply voltage is within the specified range.

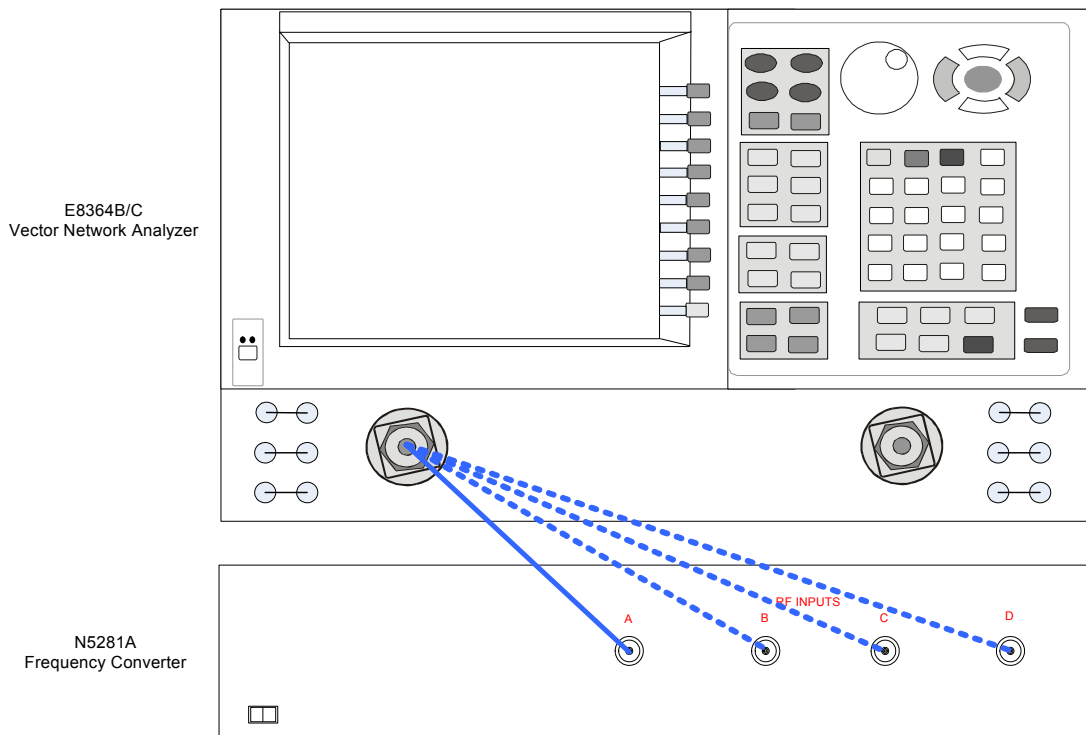
---

## Controlling the Test Set with E8363B/C or E8364B/C

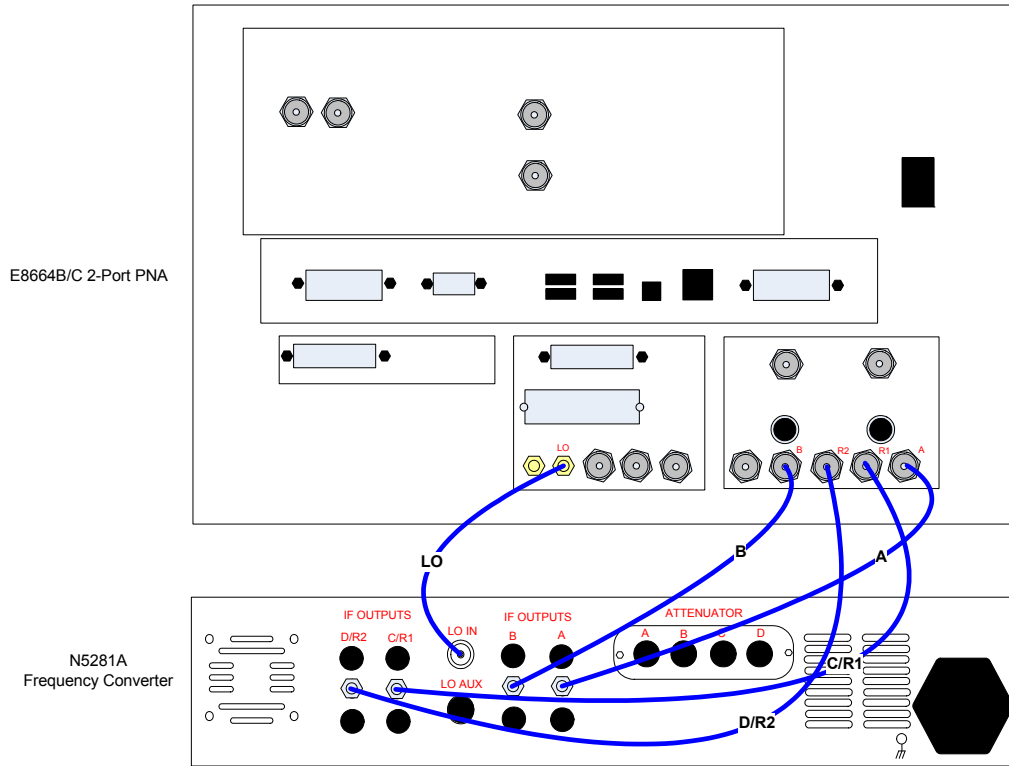
This section will describe how to setup and operate the N5281A Frequency Converter Test Set with the E8363B/C or E8364B/C PNA Network Analyzer with required Option H11, which adds IF access.

A PNA must be used to control the N5281A. The internal LO Source from the PNA can be used for testing. Refer to [Figure 10](#) and [Figure 11](#) for cable connections.

**Figure 10 Front Panel N5281A and E8364B/C**



**Figure 11 Rear Panel N5281A and E8364B/C**



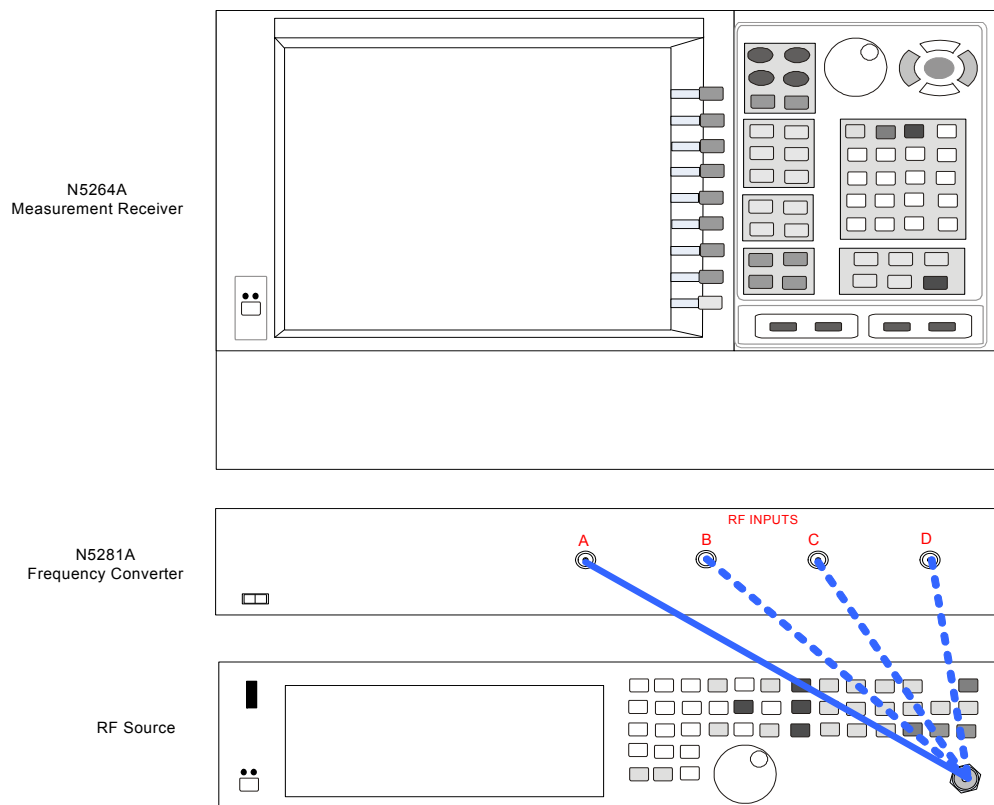
## Controlling the Test Set with N5264A

This section will describe how to setup and operate the N5281A Frequency Converter Test Set with the N5264A Measurement Receiver.

A N5264A must be used to control the N5281A. The N5264A Option 108 adds an internal LO Source 26.5 GHz for testing. Refer to [Figure 12](#) and [Figure 13 on page 19](#) for cable connections.

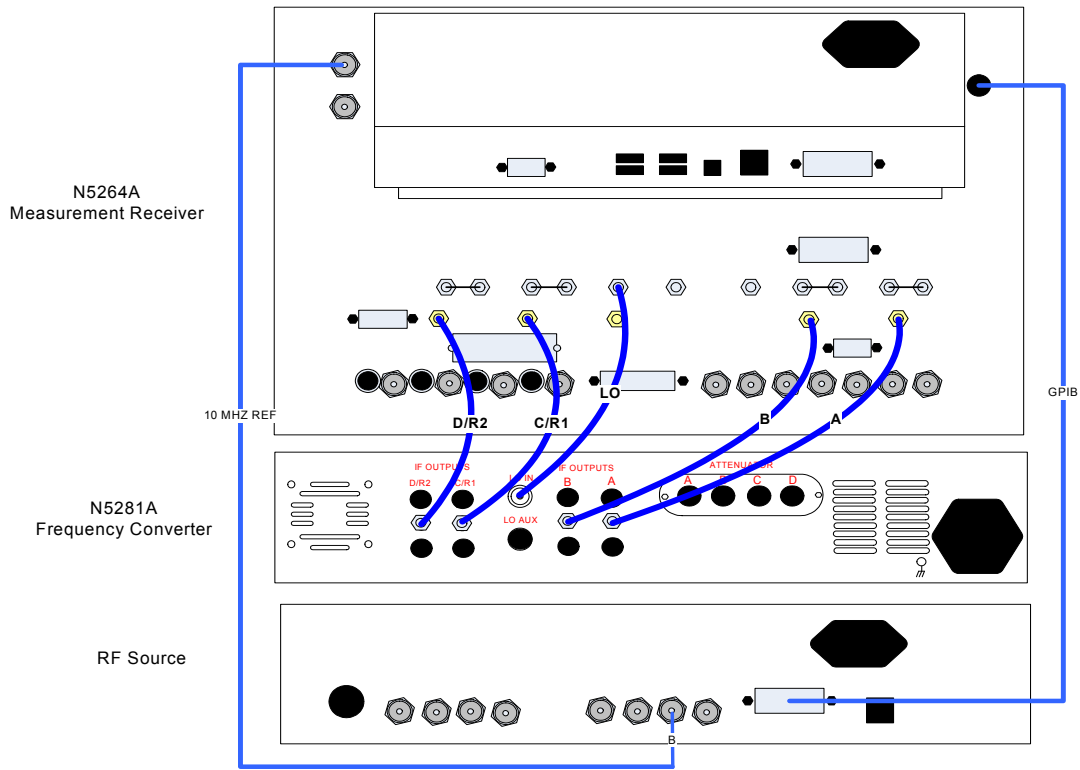
You may also use an external LO Source for testing. Refer to [Figure 14 on page 20](#) and [Figure 15 on page 21](#) for cable connections.

**Figure 12 Front Panel N5281A and N5264A with Option 108**

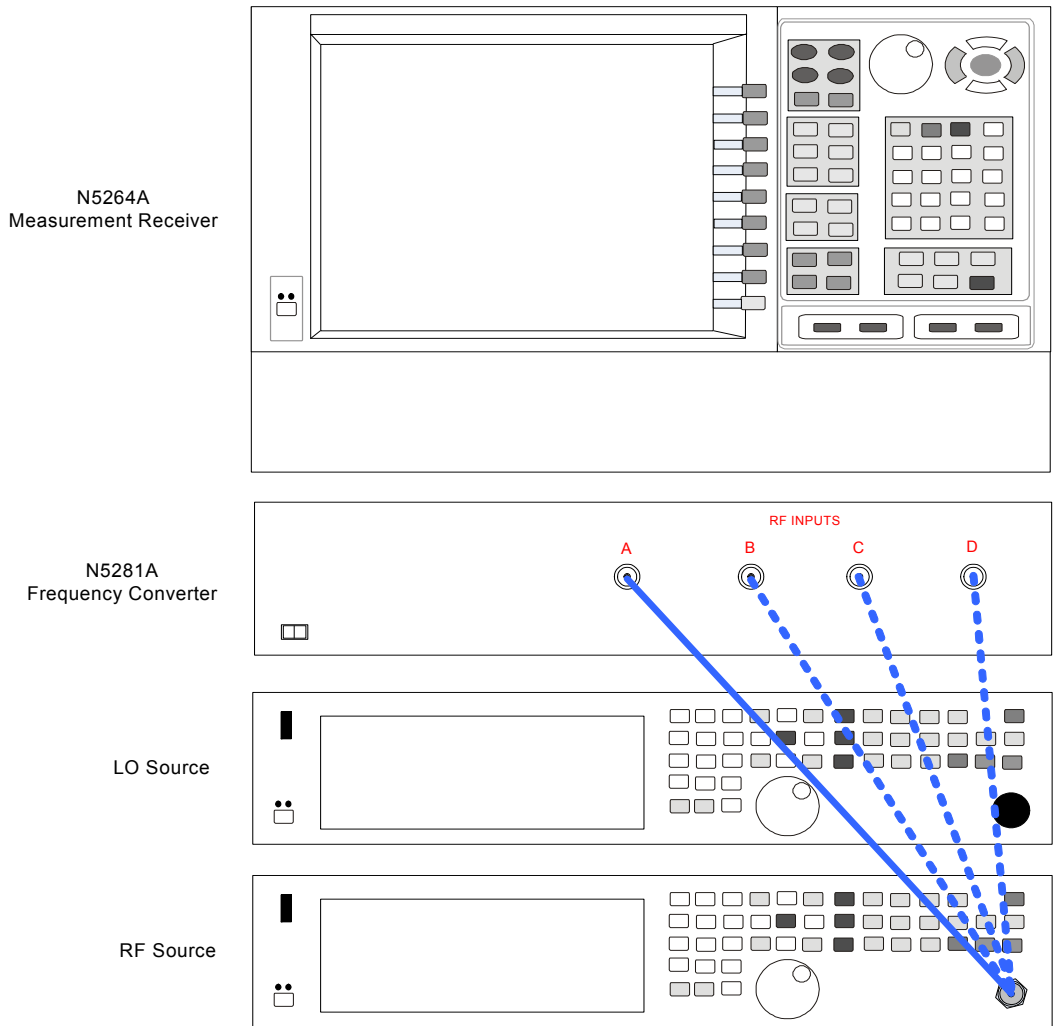




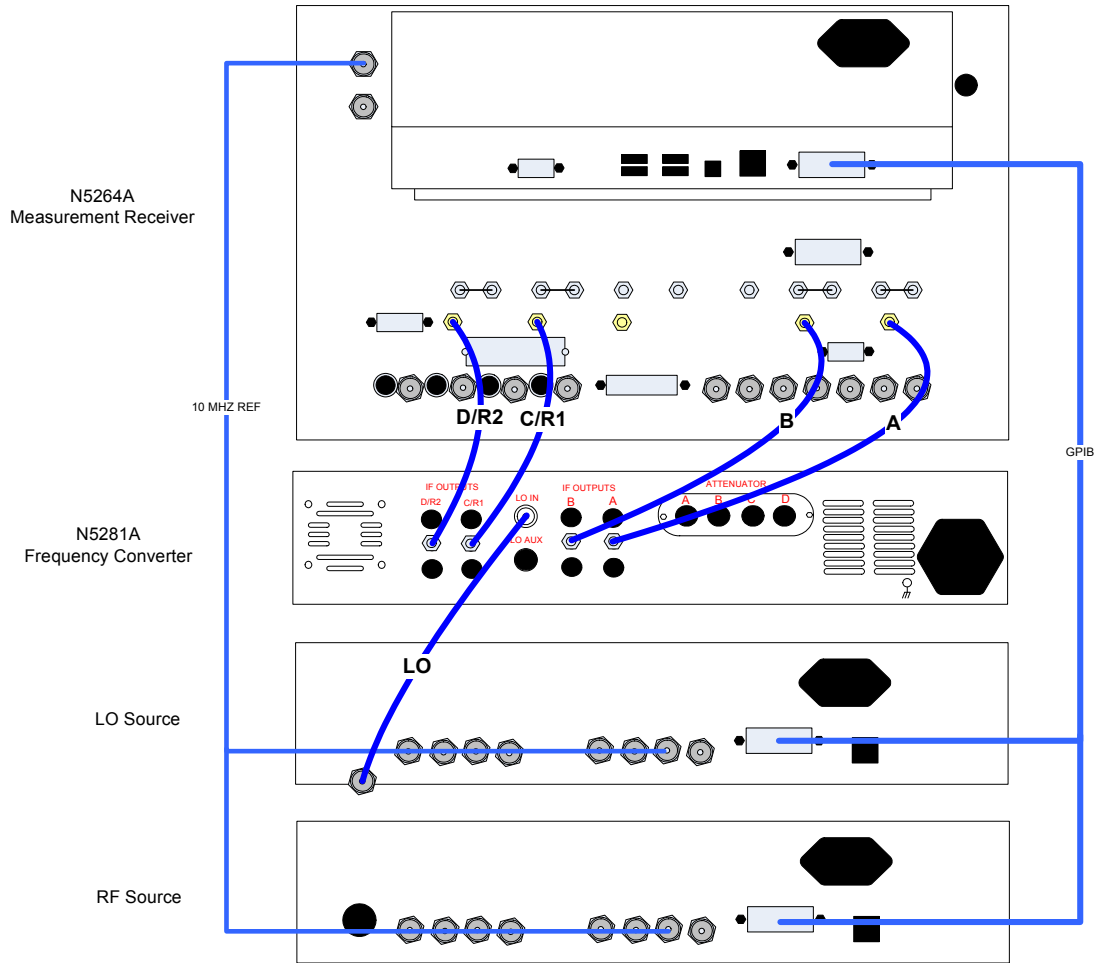
**Figure 13 Rear Panel N5281A and N5264A with Option 108**



**Figure 14 Front Panel N5281A and N5264A without Option 108**



**Figure 15 Rear Panel N5281A and N5264A without Option 108**

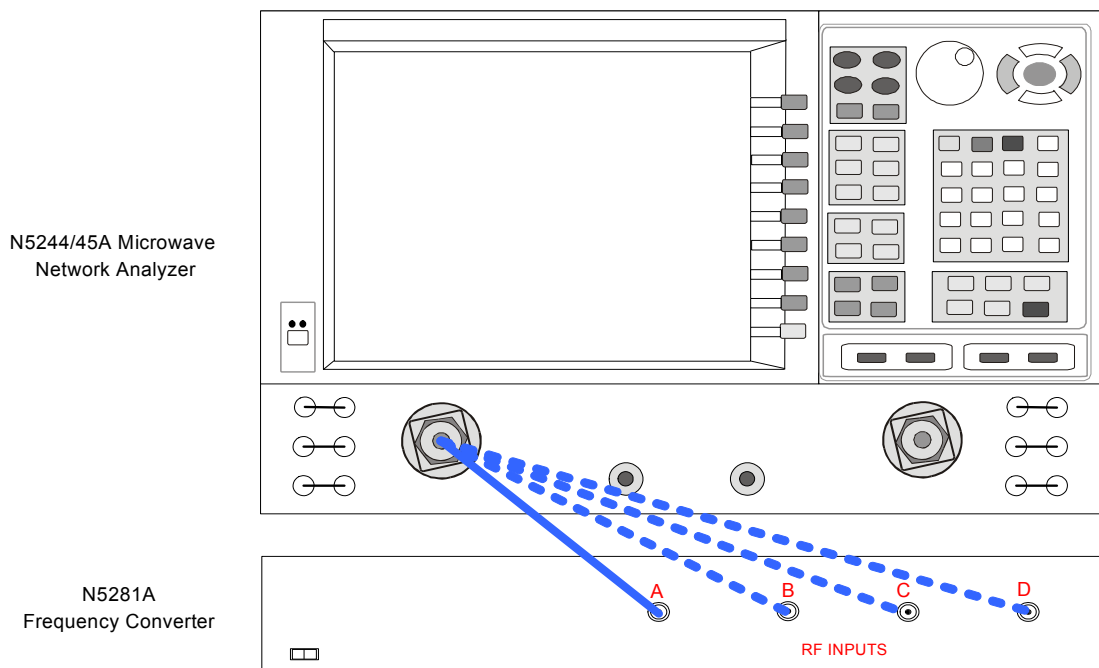


## Controlling the Test Set with N5244A or N5245A

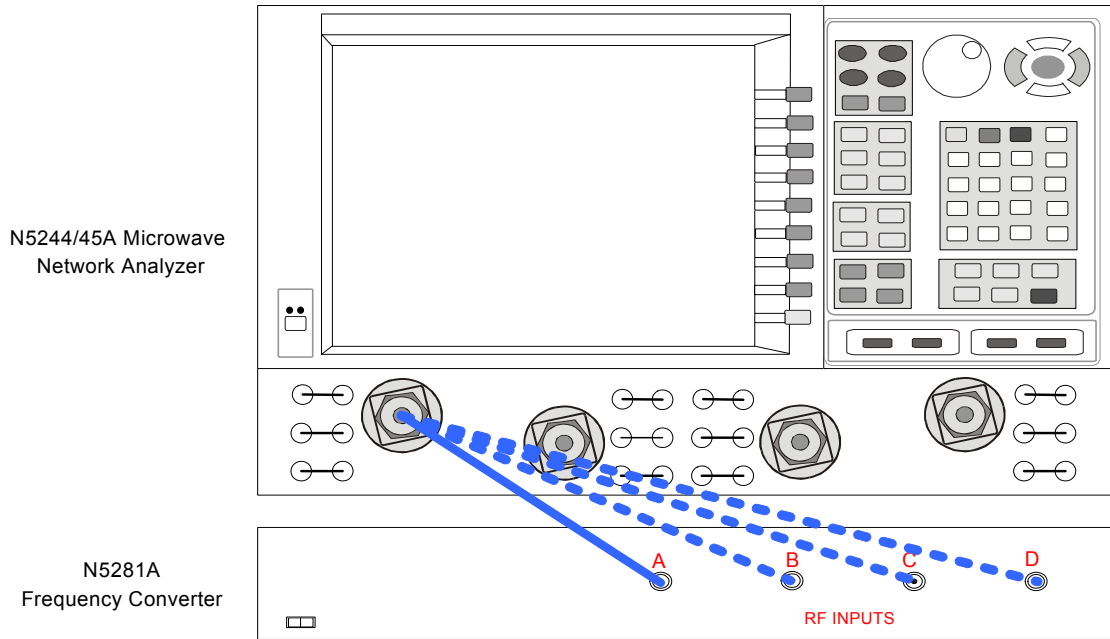
This section will describe how to setup and operate the N5281A Frequency Converter Test Set with the N5244/45A PNA-X Network Analyzer with required Option 020, which adds External IF Inputs.

A PNA-X must be used to control the N5281A. The internal LO Source from the PNA-X can be used for testing. Refer to [Figure 16](#) and [Figure 17](#) for cable connections.

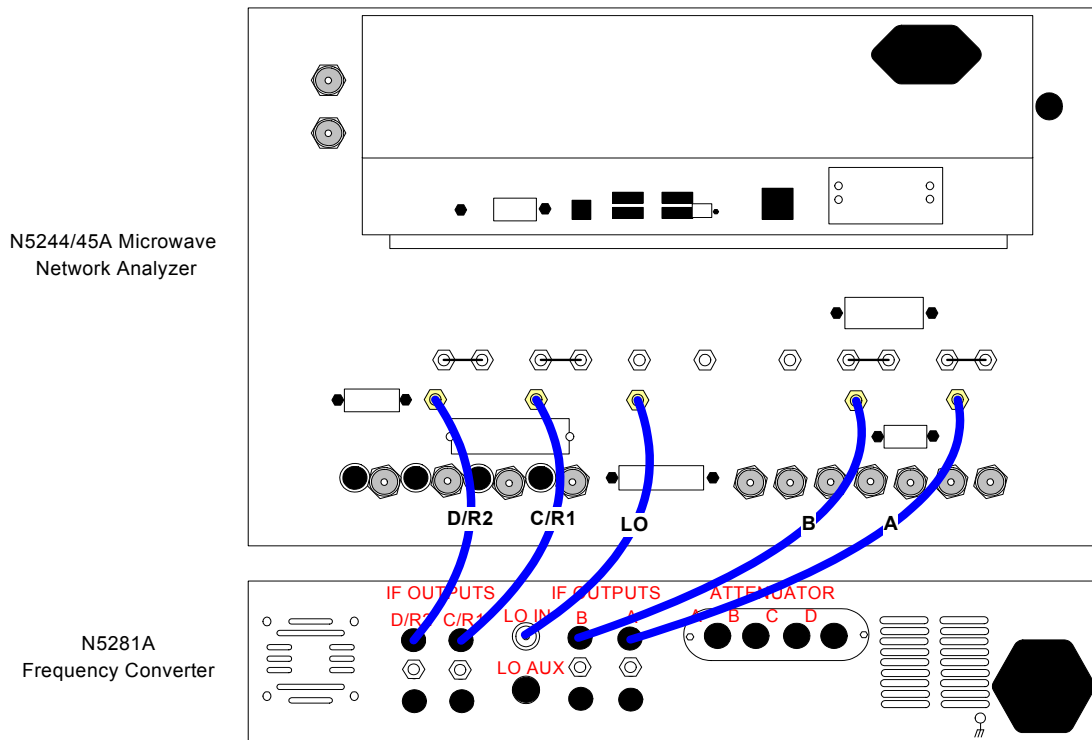
**Figure 16 Front Panel N5281A and N5244/45A (2-Port)**



**Figure 17 Front Panel N5281A and N5244/45A (4-Port)**



**Figure 18 Rear Panel N5281A and N5244/45A**



## Controlling the RF Receiver Attenuators

The 11713C attenuator switch driver controls the test set through the Viking connector on the rear panel.

**Figure 19** Rear Panel N5281A and 11713C

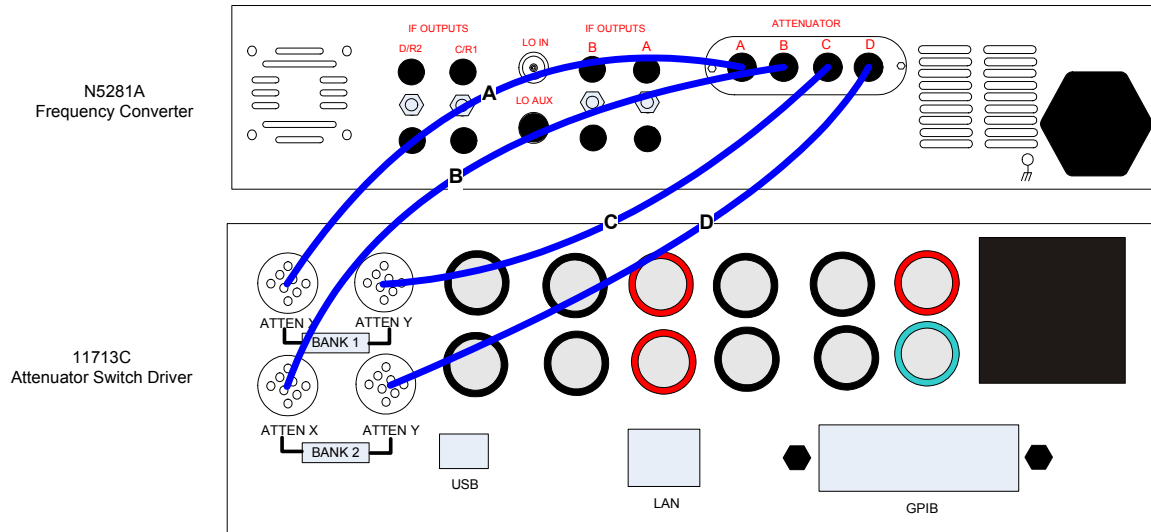


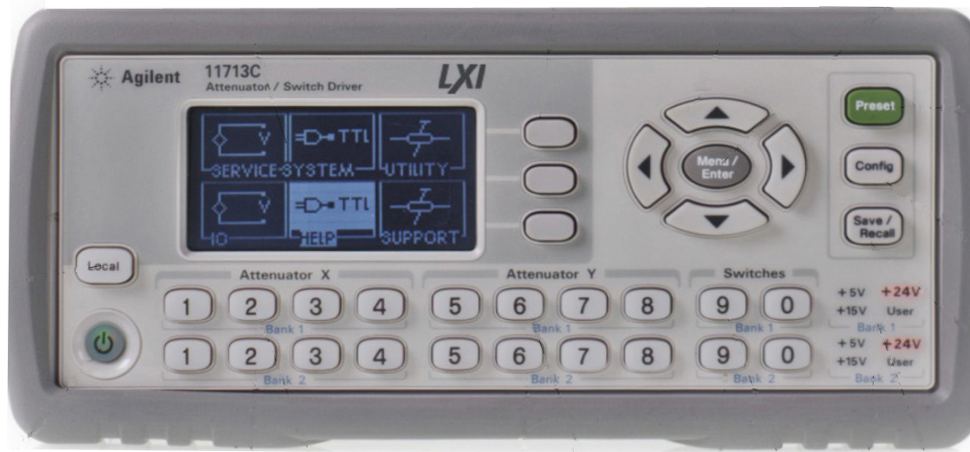
Table 7 illustrates the key combinations that are required to set the attenuation.

**Example:** In the Attenuator X panel, press 1 & 3 to set Channel A to 15 dB.

**Table 7 Attenuators**

	Attenuator X (Channel A)	Attenuator Y (Channel C)	Attenuation (dB)
Bank 1	1	5	10
	2	6	20
	3	7	5
	Attenuator X (Channel B)	Attenuator Y (Channel D)	Attenuation (dB)
Bank 2	1	5	10
	2	6	20
	3	7	5

**Figure 20 Front Panel**



## Operational Check

This section provides the operational check to confirm the N5281A, E8363B/C, E8364B/C, N5244/45A and N5264A PNA operational performance. The operation verification limits provided ensure that your N5281A and network analyzers are operating properly. Frequencies below 500 MHz are not allowed with the E8363B/C and E8364B/C PNA with Option H11.

## Equipment Required

The Agilent N5281A requires that the user be familiar with the equipment and components listed in [Table 8](#).

This section provides an equipment list and setup of the network analyzers and the test set.

**Table 8**      **Equipment List**

Description	Qty
E8363B/C 2-Port, 4 Receiver, Vector Network Analyzer, 10 MHz to 40 GHz, (Option H11) <i>or</i>	1
E8364B/C 2-Port, 4 Receiver, Vector Network Analyzer, 10 MHz to 50 GHz, (Option H11) <i>or</i>	1
N5244A 2 or 4-Port, Microwave Network Analyzer, 10 MHz to 40 GHz, (Option 020) <i>or</i>	1
N5245A 2 or 4-Port, Microwave Network Analyzer, 10 MHz to 50 GHz, (Option 020) <i>or</i>	1
N5264A Measurement Receiver (Option 108)	1



## Verification Limits

Specifications for the N5281A Multiport Test Set are typical. System performance for the network analyzer and test set are only characteristic and intended as non-warranted information. Only a functional certificate is provided for the N5281A.

It is recommended that you return your instrument to Agilent Technologies for servicing or repair if the Test Set and network analyzer performance exceed the operational verification limits.

---

**NOTE** Typical specifications are based on 1 to 2 units performance.

---

**Table 9 RF Receiver Tracking**

RF Port Magnitude Tracking	
Frequency	Value
10 MHz to 20 GHz	±2.0 dB
20 GHz to 30 GHz	±3.0 dB
30 GHz to 50 GHz	±4.0 dB

**Table 10 Noise Floor**

Direct Receiver Access Input Noise Floor <sup>1</sup> IF Bandwidth equal to 10 Hz		
Frequency	Receiver Access Input (E8364B/C)	Receiver Access Input (N5245A)
10 MHz to 500 MHz	n/a	-125 dBm
500 MHz to 2 GHz	-107 dBm	-125 dBm
2 GHz to 10 GHz	-107 dBm	-125 dBm
10 GHz to 20 GHz	-107 dBm	-120 dBm
20 GHz to 30 GHz	-107 dBm	-120 dBm
30 GHz to 40 GHz	-107 dBm	-120 dBm
40 GHz to 50 GHz	-107 dBm	-120 dBm

1. Noise floor measured with a 50 Ohm load at port, and measured as the mean value of a 801 point trace.

**Table 11 Trace Noise**

<b>Trace Noise Magnitude (dB, rms)<sup>123</sup> 1 kHz IF Bandwidth</b>		
<b>Frequency</b>	<b>Typical (E8364B/C)</b>	<b>Typical (N5245A)</b>
10 MHz to 500 MHz	n/a	0.02
500 MHz to 20 GHz	0.02	0.02
20 GHz to 40 GHz	0.04	0.04
40 GHz to 50 GHz	0.07	0.07
<b>Trace Noise Phase (deg, rms)<sup>14</sup> 1 kHz IF Bandwidth</b>		
10 MHz to 500MHz	n/a	0.15
500 MHz to 20 GHz	0.15	0.15
20 GHz to 40 GHz	0.25	0.25
40 GHz to 50 GHz	0.40	0.40

1. Trace Noise, sweep to sweep variation.
2. Measured linear magnitude CW Frequency at 201 points.
3. Trace Noise in dB = 20 \* Log 10 (1+ standard deviation).
4. Trace Noise in degrees = standard deviation.

**Table 12 Port Match**

<b>RF Port Match</b>		
<b>Frequency</b>	<b>Value(E8364B/C)</b>	<b>Value (N5245A)</b>
10 MHz to 500 GHz	n/a	< -15 dB
500 MHz to 10 GHz	< -15 dB	< -15 dB
10 GHz to 20 GHz	< -12 dB	< -12 dB
20 GHz to 30 GHz	< -10 dB	< -10 dB
30 GHz to 50 GHz	< -5 dB	< -5 dB
<b>LO Port Match</b>		
10 MHz to 26.5 GHz	n/a	< -8 dB
500 MHz to 10 GHz	< -8 dB	n/a

**Table 13 Dynamic Range**

<b>Dynamic Range @ 10 Hz IF Bandwidth</b>					
<b>Frequency</b>	<b>Typical (dB) Direct Receiver Access Input</b>		<b>Typical (dBm) Low-Level Noise Floor</b>		<b>Typical (dBm) Max Power<sup>1</sup></b>
	<b>E8363/64B/C</b>	<b>N5244/45A</b>	<b>E8363/64B/C</b>	<b>N5244/45A</b>	<b>Option 700 &amp; 001</b>
10 MHz to 500 MHz	n/a	-115	n/a	-125	-10
500 MHz to 2 GHz	97	-115	-107	-125	-10
2 GHz to 10 GHz	97	-115	-107	-125	-10
10 GHz to 20 GHz	97	-110	-107	-120	-10
20 GHz to 30 GHz	97	-110	-107	-120	-10
30 GHz to 40 GHz	97	-110	-107	-120	-10
40 GHz to 50 GHz	97	-110	-107	-120	-10

1. RCVR IN @ 0.1 dB typical compression at max power.

The receiver access input dynamic range is calculated as the difference between the receiver access input low-level noise floor, and the source maximum power to the receiver that results with a typical 0.1 dB compression level.

Low-level noise floor measured with 50 Ohm load at the port.

The effective dynamic range must take measurement uncertainties and interfering signals into account. This set-up should only be used when the receiver input will not exceed its compression or damage level.

## E8364B/C Operational Check Procedure

The sequence of this procedure is very important and must be followed or the performance accuracy and results may vary from the reference plots provided.

---

**NOTE** If you are using a E8364B or E8364C 2-Port PNA-X, channels C and D will be replaced with R1 and R2.

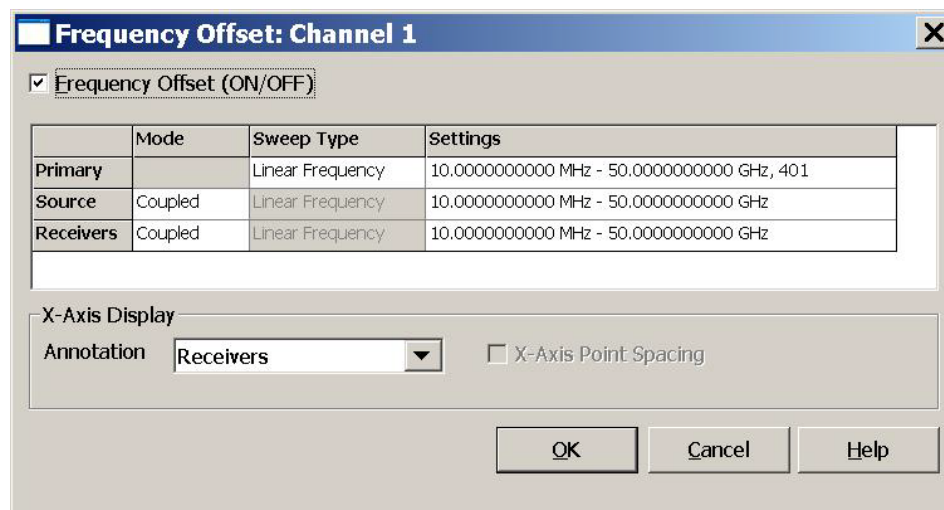
---

The following procedures are used with the E8364B/C.

### Preparing the E8364B/C

1. Connect the Test Set to the E8364B/C using the cables as shown in [Figure 10 on page 16](#) and [Figure 11 on page 17](#).
2. Connect the 10 dB attenuator to the PNA-X reference port cable.
3. Turn On the Test Set.
4. Select [**Preset**].
5. Verify that the Stop Frequency is set to the maximum frequency of the PNA and test set. If not, select [**Freq**] > **Stop**.
6. Verify that the Start Frequency is set to 10 MHz. If not, select [**Freq**] > **Start** > [**10 MHz**].
7. Verify that the Power is to set to -17 dBm. If not, select [**Power**] > **Power Level** > [**-17 dBm**].
8. Select [**Avg**] > **IF Bandwidth** > [**1 kHz**].
9. Select [**Sweep**] > **Number of Points** > [**401**].
10. Allow the test set and the PNA to warm up for a minimum of 30 minutes.
11. Select [**Freq**] > **Frequency Offset** > select **Frequency Offset (ON/OFF)** > **OK**.

**Figure 21** Frequency Offset



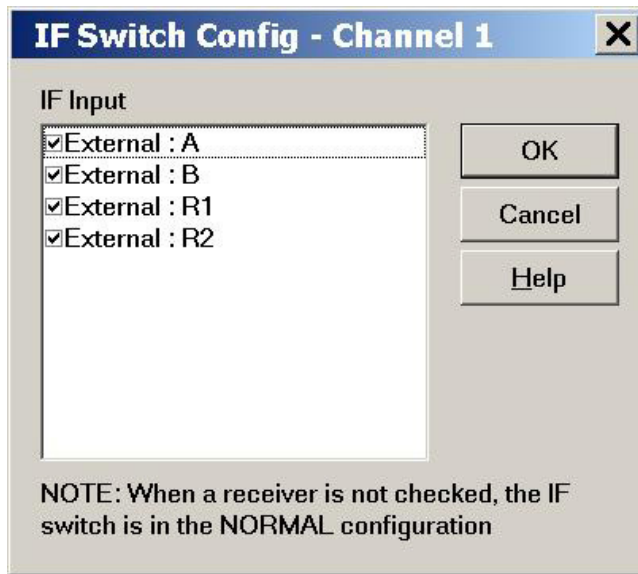
12. Set the IF Switch Config On. In the drop-down window select **Trace/Chan > Channel > Hardware Setup > IF Switch Config**.

**Figure 22 IF Switch Config**



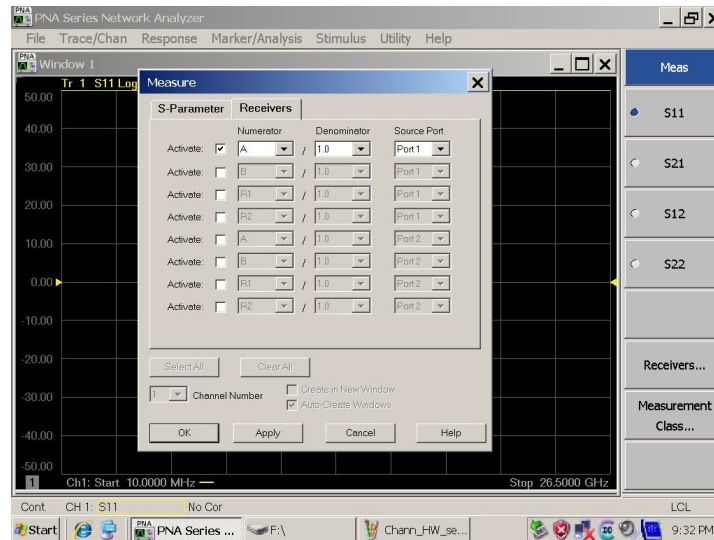
13. Select all of the IF Inputs **External A, B, R1 and R2 > OK**.

**Figure 23 IF Input**



14. Connect the cable to **A, RF INPUTS** on the test set. Select **[Meas] > Receivers**, select **A > Apply > OK**.

**Figure 24 Receiver A**



15. Set the Reference level is at 0 dBm. Select **[Scale] > Reference level > [0 dBm]**.

**Figure 25 Typical Receiver A**



16. Connect the cable to **B, RF INPUTS** on the test set. Select **[Meas] > Receivers**, select **B > Apply > OK** to observe the power level trace.
17. Connect the cable to **C, RF INPUTS** on the test set. Select **[Meas] > Receivers**, select **R1 > Apply > OK** to observe the power level trace.
18. Connect the cable to **D, RF INPUTS** on the test set. Select **[Meas] > Receivers**, select **R2 > Apply > OK** to observe the power level trace.

## N5245A Operational Check Procedure

The sequence of this procedure is very important and must be followed or the performance accuracy and results may vary from the reference plots provided.

---

**NOTE** If you are using a N5244A or N5245A 2-Port PNA-X, channels C and D will be replaced with R1 and R2.

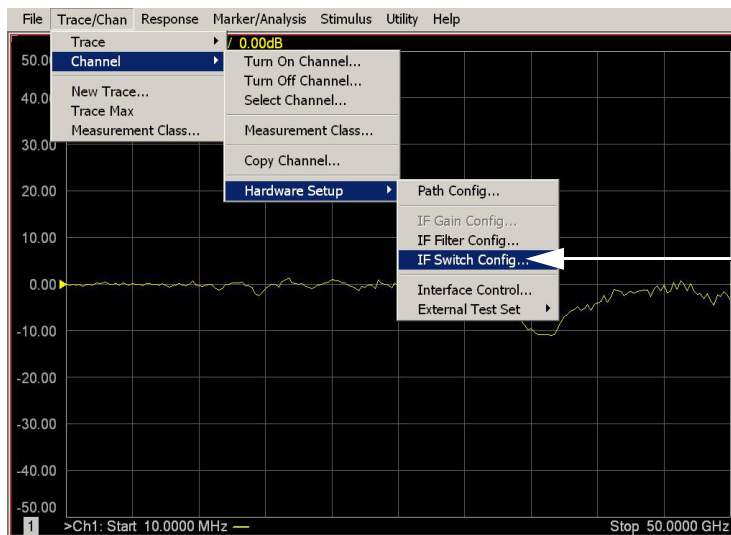
---

The following procedures are used with the N5245A.

### Preparing the N5245A

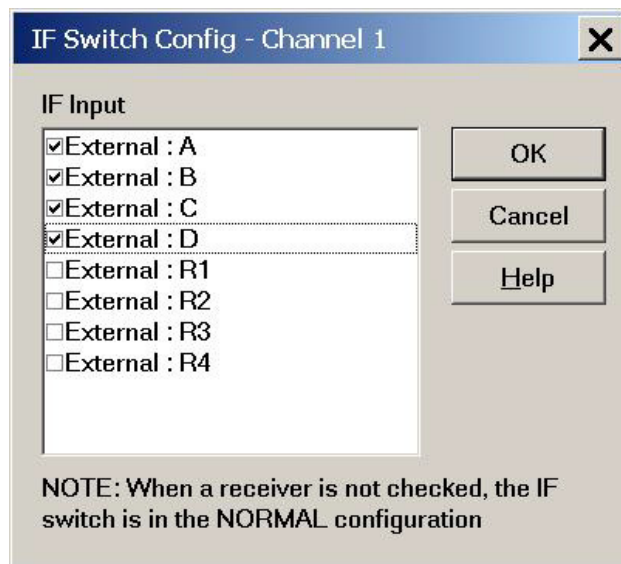
1. Connect the Test Set to the N5245A using the cables as shown in [Figure 16 on page 22](#), [Figure 17 on page 23](#) and [Figure 18 on page 23](#).
2. Connect the 10 dB attenuator to the PNA-X reference port cable.
3. Turn On the Test Set.
4. Select [**Preset**].
5. Verify that the Stop Frequency is set to the maximum frequency of the PNA and test set. If not, select [**Freq**] > **Stop**.
6. Verify that the Start Frequency is set to 10 MHz. If not, select [**Freq**] > **Start** > [**10 MHz**].
7. Verify that the Power is set to -5 dBm. If not, select [**Power**] > **Power Level** > [**-5 dBm**].
8. Select [**Avg**] > **IF Bandwidth** > [**1 kHz**].
9. Select [**Sweep**] > **Number of Points** > [**401**].
10. Allow the test set and the PNA to warm up for a minimum of 30 minutes.
11. Set the IF Switch Config On. In the drop-down window select **Trace/Chan** > **Channel** > **Hardware Setup** > **IF Switch Config**.

**Figure 26** IF Switch Config



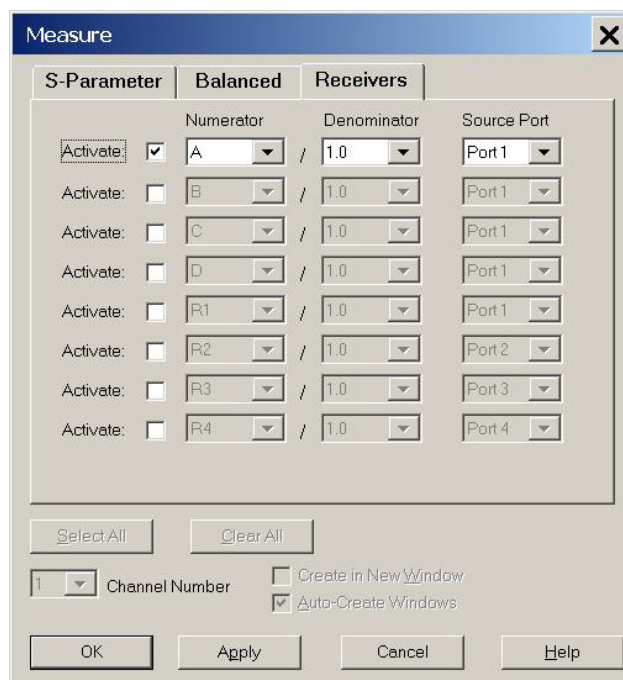
12. Select all of the IF Inputs **External A, B, C and D** > **OK**.

**Figure 27 IF Input**



13. Connect the cable to **A, RF INPUTS** on the test set. Select [**Meas**] > **More** > **Receivers**, select **A** > **Apply** > **OK**.

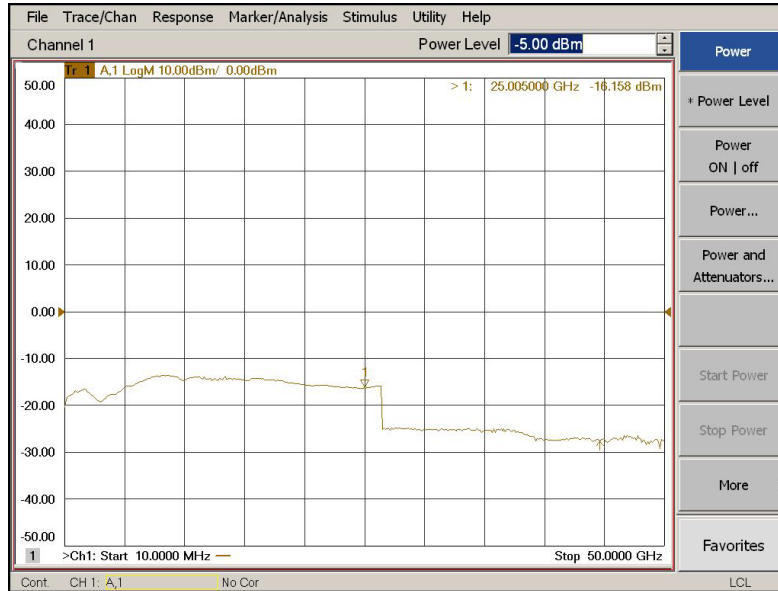
**Figure 28 Receiver A**





14. Set the Reference level is to 0 dBm. Select **[Scale]** > **Reference level** > **[0 dBm]**.

**Figure 29 Typical Receiver A**



15. Connect the cable to **B, RF INPUTS** on the test set. Select **[Meas]** > **More** > **Receivers**, select **B** > **Apply** > **OK** to observe the power level trace.
16. Connect the cable to **C, RF INPUTS** on the test set. Select **[Meas]** > **More** > **Receivers**, select **C** > **Apply** > **OK** to observe the power level trace.
17. Connect the cable to **D, RF INPUTS** on the test set. Select **[Meas]** > **More** > **Receivers**, select **D** > **Apply** > **OK** to observe the power level trace.

### Attenuator Element Verification Procedure

The Attenuator Element Verification Procedure is a functional test only. This test verifies the functionality of the variable attenuator in each channel RF path. The following procedures are used with the 11713C attenuator switch driver.

1. Connect the cables from the test set to the 11713C as shown in [Figure 19 on page 24](#).
2. Select **[Preset]**.
3. Select **[Freq] > Frequency Offset > select Frequency Offset (ON/OFF) > OK**. Refer to [Figure 21 on page 30](#).
4. Set the IF Switch Config On. Select **Trace/Chan > Channel > Hardware Setup > IF Switch Config**. Refer to [Figure 22 on page 31](#).
5. Select all of the IF Inputs **External A, B, R1 and R2 > OK**. Refer to [Figure 23 on page 31](#).
6. Select **[Analysis] > Statistics On**.
7. Connect the cable to **A, RF INPUTS** on the test set. Select **[Meas] > Receivers** and select **A > Apply > OK**. Refer to [Figure 24 on page 32](#).
8. Select **[Memory] > Normalize**.
9. Select **[1]** on the 11713C. The mean value should read  $-10$  dB ( $\pm 1$  dB). Select **[1]** again, it should read 0 dB.
10. Select **[2]** on the 11713C. The mean value should read  $-20$  dB ( $\pm 1$  dB). Select **[2]** again, it should read 0 dB.
11. Select **[3]** on the 11713C. The mean value should read  $-5$  dB ( $\pm 1$  dB). Select **[3]** again, it should read 0 dB.
12. Repeat [step 7](#) through [step 11](#) for **Channel B, C and D RF INPUTS**.

**Figure 30 N5281A Block Diagram (Standard 700)**

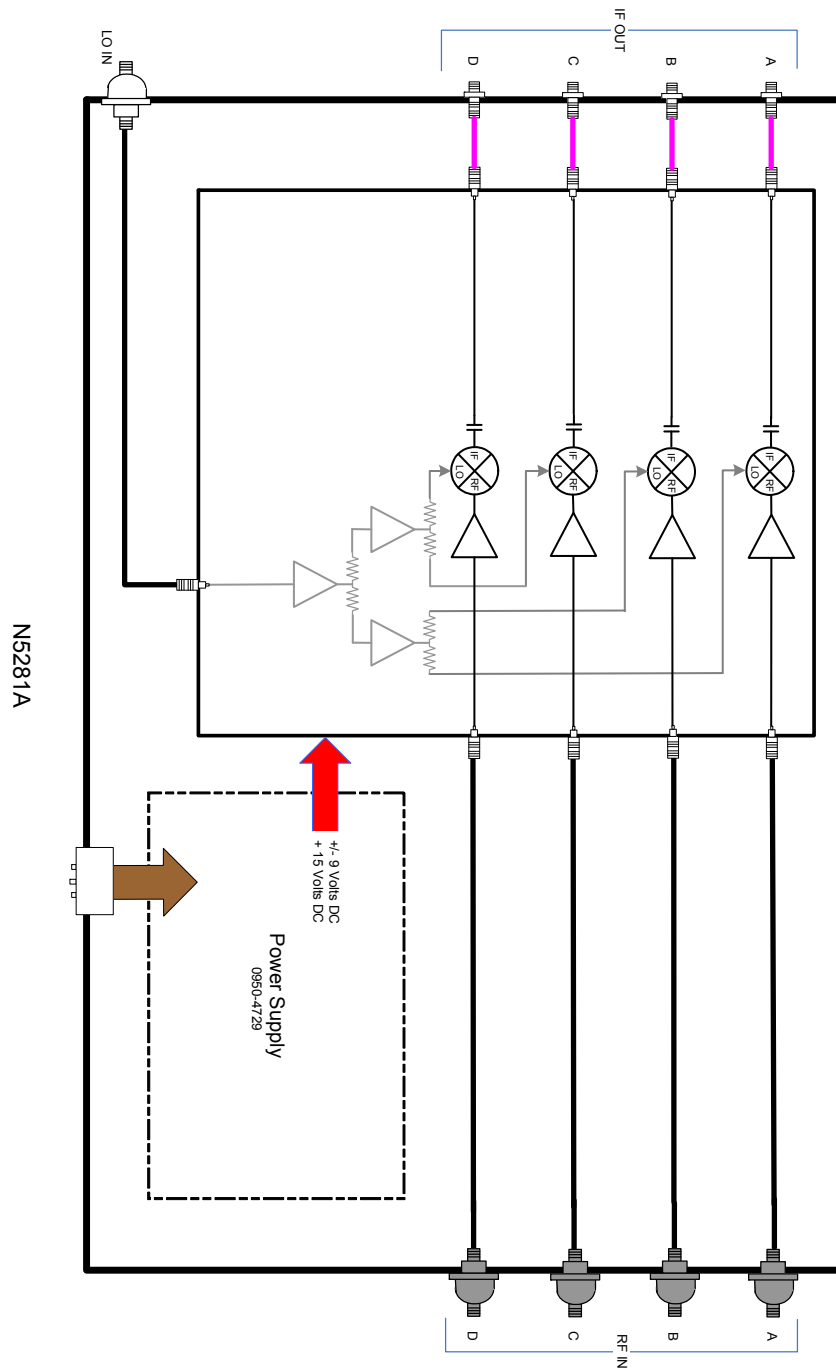
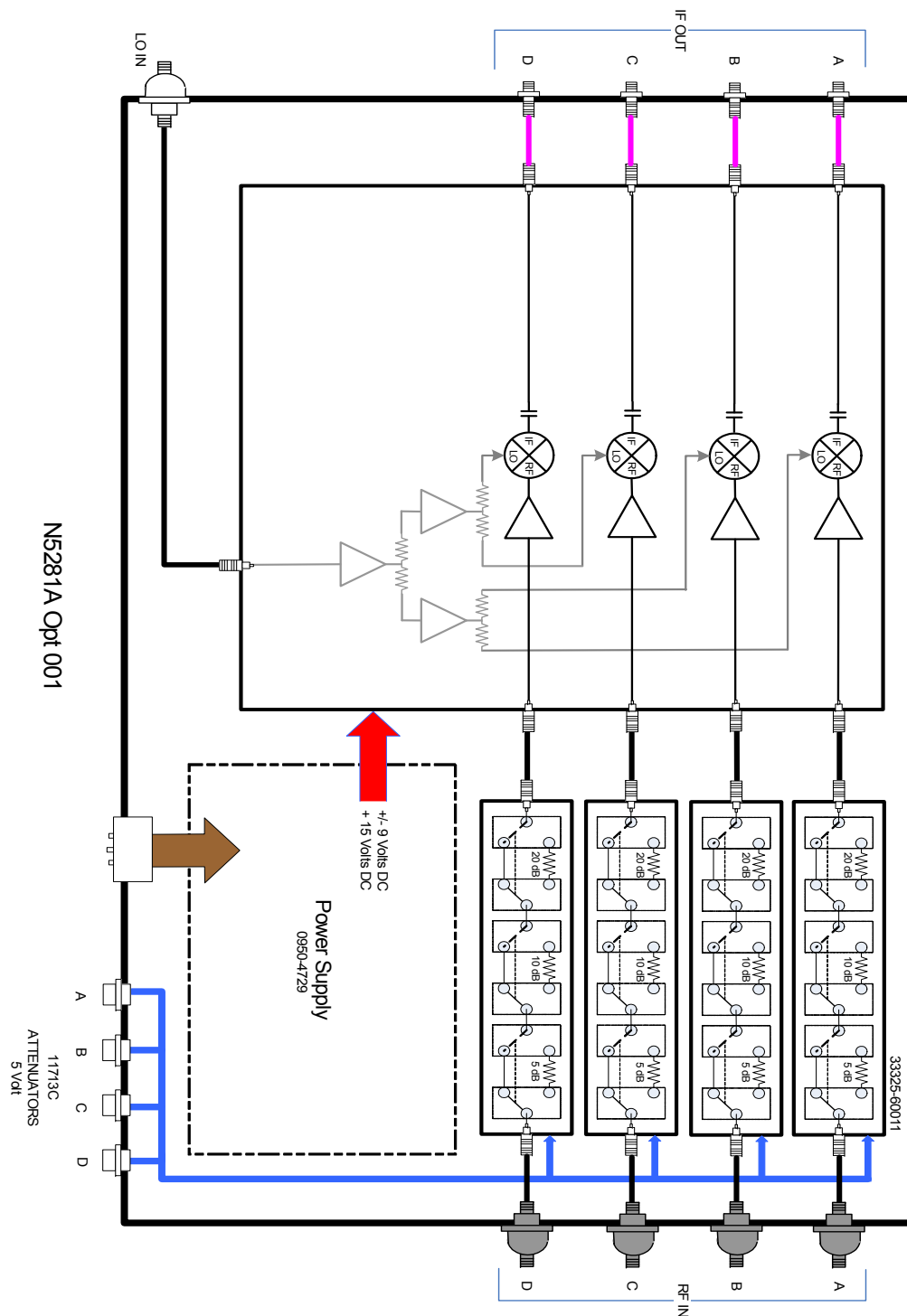


Figure 31 N5281A Block Diagram (Option 001)



---

## Service Information

There are many other repair and calibration options available from the Agilent Technologies support organization. These options cover a range of service agreements with varying response times. Contact Agilent for additional information on available service agreements for this product.

---

**WARNING**     **No operator serviceable parts inside. Refer servicing to qualified personnel. To prevent electrical shock do not remove covers.**

---

---

**WARNING**     **These servicing instructions are for use by qualified personnel only. To avoid electrical shock, do not perform any servicing unless you are qualified to do so.**

---

## Replaceable Parts

Special options are built to order, long lead times may be encountered when ordering replacement parts.

**Table 14 Replaceable Parts for Serial Numbers US48480101, US48480103 and US48480104**

Description		Agilent Part Number
1	PWR Supply (AC/DC SWG 650 W 9-Output)	0950-4729
2	Fuse (8 A 250 V non-time delay 0.0146 Ohm)	2110-0342
3	Mixer Brick Bias Board Assembly	N5280-63015
4	Mixer Brick 50 GHz Assembly	5087-7279
5	3.5 mm Bulkhead Connector (female)	5062-6618
6	2.4 mm Bulkhead Connector (female)	5062-7243
7	RF Cable, semi-rigid (MXB to LO IN)	N5281-20001
N5281A Option 700 (Standard):		
8	RF Cable, semi-rigid (MXB to C)	N5281-20002
9	RF Cable, semi-rigid (MXB to B)	N5281-20003
10	RF Cable, semi-rigid (MXB to D)	N5281-20004
11	RF Cable, semi-rigid (MXB to A)	N5281-20005
N5281A Option 001:		
12	Attenuator (35 dB) 50 GHz, 3-Section Y-Contact, 5 V, 2.4 mm Connector	33325-60011
13	RF Cable, semi-rigid (ATTN-A to MXB)	N5281-20006
14	RF Cable, semi-rigid (ATTN-D to MXB)	N5281-20007
15	RF Cable, semi-rigid (ATTN-B to MXB)	N5281-20008
16	RF Cable, semi-rigid (ATTN-C to MXB)	N5281-20009
17	RF Cable, semi-rigid (ATTN-D to D)	N5281-20010
18	RF Cable, semi-rigid (ATTN-B to B)	N5281-20011
19	RF Cable, semi-rigid (ATTN-C to C)	N5281-20012
20	RF Cable, semi-rigid (ATTN-A to A)	N5281-20013

**Figure 32 N5281A Option 700**

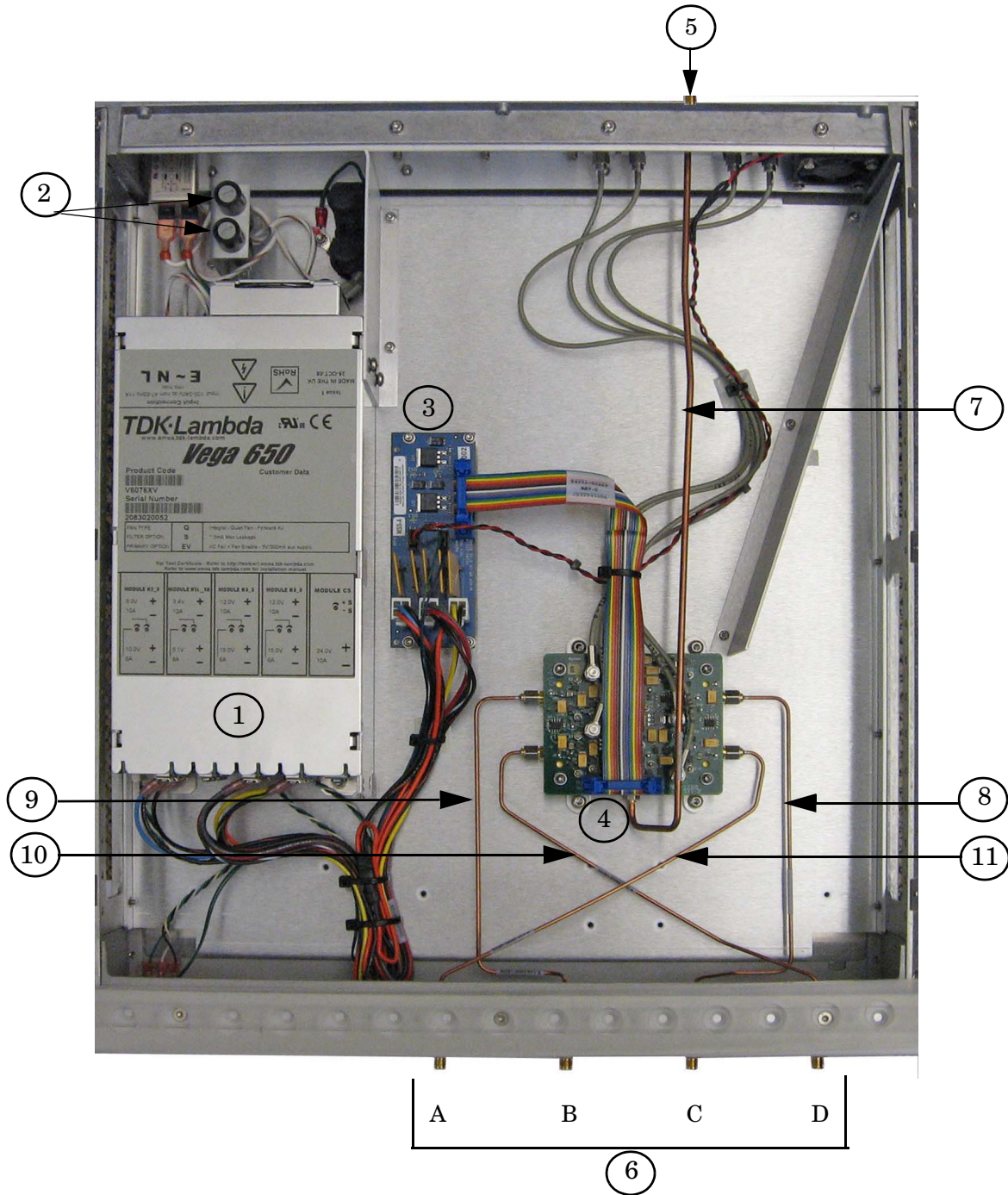
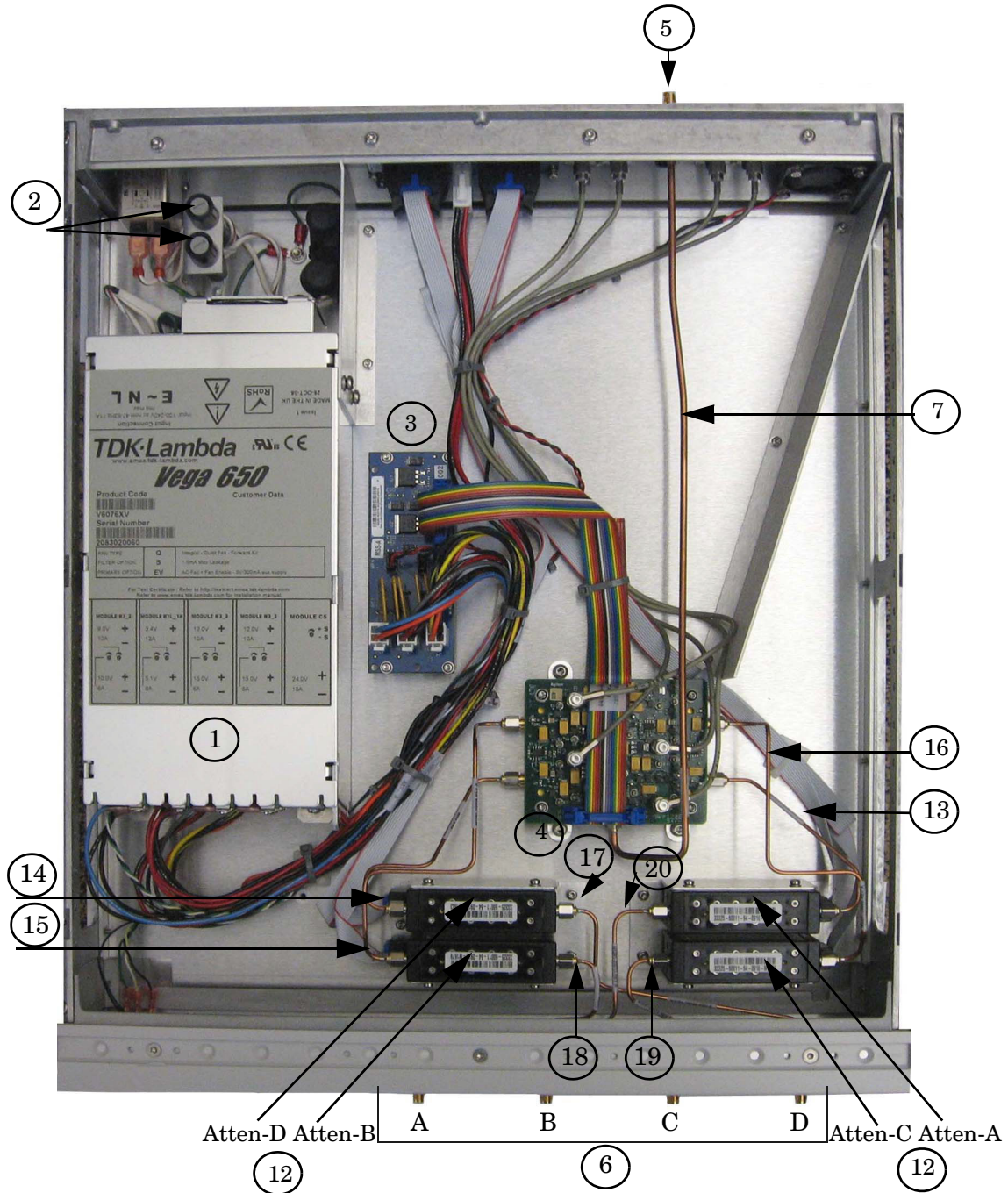


Figure 33 N5281A Option 001

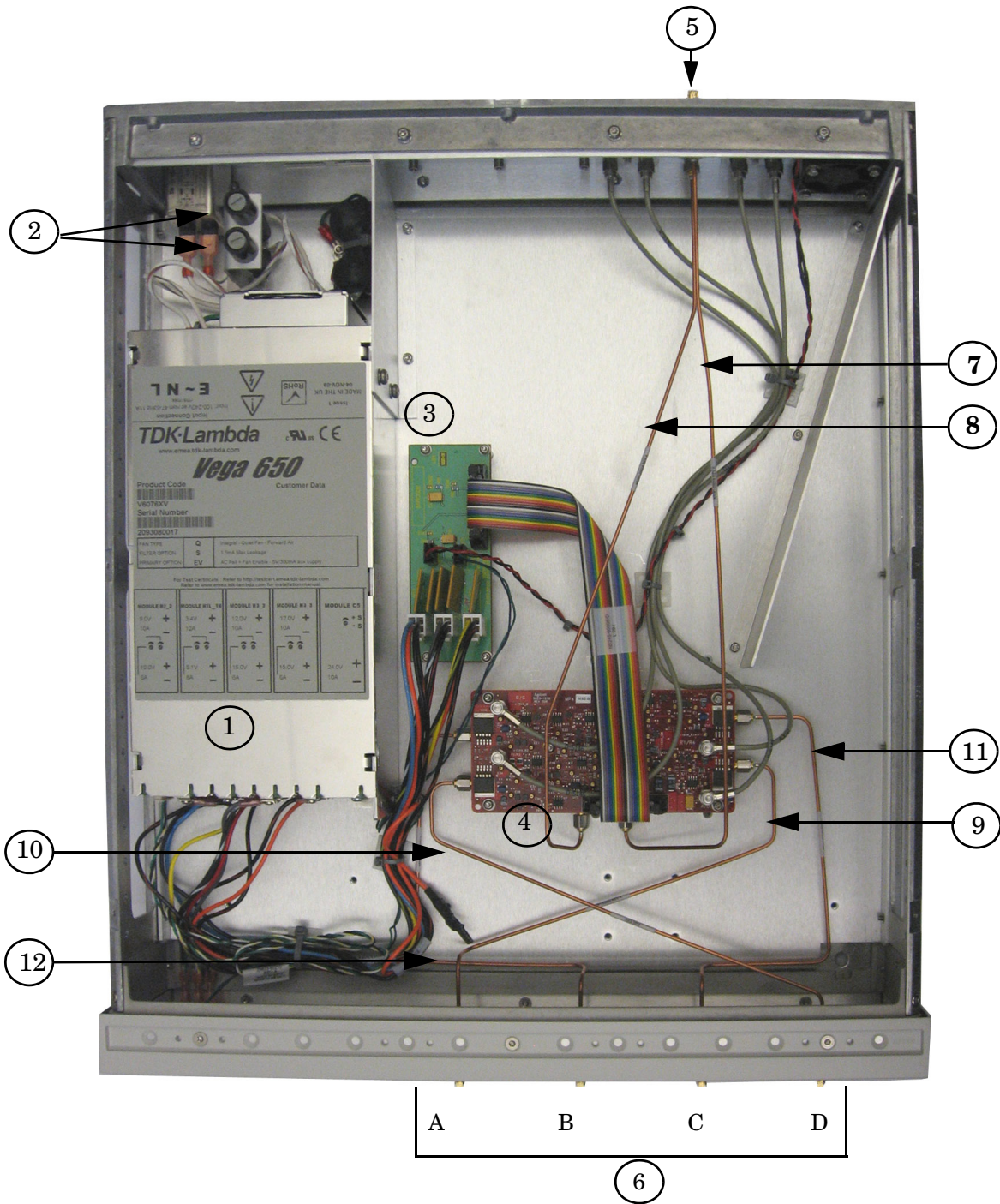




**Table 15 Replaceable Parts for Serial Numbers US48480102, US48480105 and Greater**

Description		Agilent Part Number
1	PWR Supply (AC/DC SWG 650 W 9-Output)	0950-4729
2	Fuse (8 A 250 V non-time delay 0.0146 Ohm)	2110-0342
3	Mixer Brick Bias Board Assembly	N5280-63015
4	Mixer Brick 50 GHz Assembly	5087-7323
5	3.5 mm Bulkhead Connector (female)	5062-6618
6	2.4 mm Bulkhead Connector (female)	5062-7243
7	RF Cable, semi-rigid (LO IN)	N5281-20018
8	RF Cable, semi-rigid (LO OUT)	N5281-20019
<b>N5281A Option 700 (Standard):</b>		
9	RF Cable, semi-rigid (MXB-A/D to RF-A)	N5281-20020
10	RF Cable, semi-rigid (MXB-R2/R3 to RF-D)	N5281-20021
11	RF Cable, semi-rigid (MXB-R1/R4 to RF-C)	N5281-20022
12	RF Cable, semi-rigid (MXB-B/C to RF-B)	N5281-20023
<b>N5281A Option 001:</b>		
13	Attenuator (35 dB) 50 GHz, 3-Section Y-Contact, 5 V, 2.4 mm Connector	33325-60011
14	RF Cable, semi-rigid (ATTN-D to D)	N5281-20010
15	RF Cable, semi-rigid (ATTN-B to B)	N5281-20011
16	RF Cable, semi-rigid (ATTN-C to C)	N5281-20012
17	RF Cable, semi-rigid (ATTN-A to A)	N5281-20013
18	RF Cable, semi-rigid (MXB-B/C ATTN-B)	N5281-20014
19	RF Cable, semi-rigid (MXB-R2/R3 to ATTN-D)	N5281-20015
20	RF Cable, semi-rigid (MXB-A/D to ATTN-A)	N5281-20016
21	RF Cable, semi-rigid (MXB-R1/R4 to ATTN-C)	N5281-20017

Figure 34 N5281A Option 700



---

## Safety and Regulatory Information

### Introduction

Review this product and related documentation to familiarize yourself with safety markings and instructions before you operate the instrument. The documentation contains information and warnings that must be followed by the user to ensure safe operation and to maintain the product in a safe condition.

### Before Applying Power

Verify that the premises electrical supply is within the range of the instrument. The instrument has an autoranging power supply.

---

**WARNING**     **To prevent electrical shock, disconnect the [Agilent Technologies N5281A](#) from mains power supply before cleaning. Use a dry cloth or one slightly dampened with water to clean the external case parts. Do not attempt to clean internally.**

---

### Connector Care and Cleaning

If alcohol is used to clean the connectors, the power cord to the instrument must be removed. All cleaning should take place in a well ventilated area. Allow adequate time for the fumes to disperse and moist alcohol to evaporate prior to energizing the instrument.

---

**WARNING**     **Keep isopropyl alcohol away from heat, sparks, and flame. Store in a tightly closed container. It is extremely flammable. In case of fire, use alcohol foam, dry chemical, or carbon dioxide; water may be ineffective.**

---

### Declaration of Conformity

A declaration of conformity is on file for the PNA models, and a copy is available upon request, or a copy is available on the Agilent Technologies web site at <http://regulations.corporate.agilent.com/DoC/search.htm>

### Statement of Compliance

This instrument has been designed and tested in accordance with CAN/CSA 22.2 No. 61010-1-04, UL Std No. 61010-1 (Second Edition), and IEC 61010-1 (Second Edition).

## Shipping Your Analyzer to Agilent for Service or Repair

The N5281A instrument is to be returned to factory for service or repair.

You must always call the Agilent Technologies Instrument Support Center to initiate service before retuning your instrument to a service office. See [“Contacting Agilent Sales and Service Offices” on page 51](#). Always transport or ship the instrument using the original packaging if possible. If not, comparable packaging must be used. Attach a complete description of the failure symptoms.

## Battery Collection

Do not throw batteries away but collect as small chemical waste, or in accordance with your country’s requirements. You may return the battery to Agilent Technologies for disposal. Refer to [“Contacting Agilent Sales and Service Offices” on page 51](#) for assistance.

## Compliance with German Noise Requirements

This is to declare that this instrument is in conformance with the German Regulation on Noise Declaration for Machines (Laermangabe nach der Maschinenlaermverordnung-3. GSGV Deutschland).

Acoustic Noise Emission/Geraeuschemission	
LpA<70 dB	Lpa<70 dB
Operator Position	am Arbeitsplatz
Normal Operation	normaler Betrieb
per ISO 7779	nach DIN 45635 t. 19

## EMC Information

Complies with European EMC Directive 2004/108/EC

- IEC/EN 61326-1
- CISPR Pub 11 Group 1, class A
- AS/NZS CISPR 11
- This ISM device complies with Canadian ICES-001.  
Cet appareil ISM est conforme a la norme NMB du Canada.

## Warnings

---

**WARNING**     **The WARNING notice denotes a hazard. It calls attention to a procedure, practice, or the like, which if not correctly performed or adhered to, could result in personal injury. Do not proceed beyond a WARNING notice until the indicated conditions are fully understood and met.**

---

Warnings applicable to this instrument are:

---

**WARNING**     **Verify that the premise electrical voltage supply is within the range specified on the instrument.**

---

---

**WARNING**     **This is a Safety Class I product (provided with a protective earthing ground incorporated in the power cord). The mains plug shall be inserted only into a socket outlet provided with a protective earth contact. Any interruption of the protective conductor, inside or outside the instrument, is likely to make the instrument dangerous. Intentional interruption is prohibited.**

---

---

**WARNING**     **No operator serviceable parts inside. Refer servicing to qualified personnel. To prevent electrical shock do not remove covers.**

---

---

**WARNING**     **The opening of covers or removal of parts is likely to expose the user to dangerous voltages. Disconnect the instrument from all voltage sources while it is being opened.**

---

---

**WARNING**     **If this product is not used as specified, the protection provided by the equipment could be impaired. This product must be used in a normal condition (in which all means for protection are intact) only.**

---

---

**WARNING**     **The detachable power cord is the instrument disconnecting device. It disconnects the mains circuits from the mains supply before other parts of the instrument. The front panel switch is only a standby switch and is not a LINE switch (disconnecting device).**

---

## Cautions

---

**CAUTION** The CAUTION notice denotes a hazard. It calls attention to an operating procedure, practice, or the like, which if not correctly performed or adhered to, could result in damage to the product or loss of important data. Do not proceed beyond a CAUTION notice until the indicated conditions are fully understood and met.

---

Cautions applicable to this instrument are:

---

**CAUTION** Always use the three-prong ac power cord supplied with this instrument. Failure to ensure adequate earth grounding (by not using this cord) can cause instrument damage and the risk of electrical shock.

---

---

**CAUTION** Ventilation Requirements: When installing the instrument in a cabinet, the convection into and out of the instrument must not be restricted. The ambient temperature (outside the cabinet) must be less than the maximum operating temperature of the instrument by 4 °C for every 100 watts dissipated in the cabinet. If the total power dissipated in the cabinet is greater than 800 watts, forced convection must be used.

---

---

**CAUTION** This product is designed for use in Installation Category II and Pollution Degree 2.

---

---

**CAUTION** Verify that the premise electrical voltage supply is within the range specified on the instrument.

---

## Instrument Markings

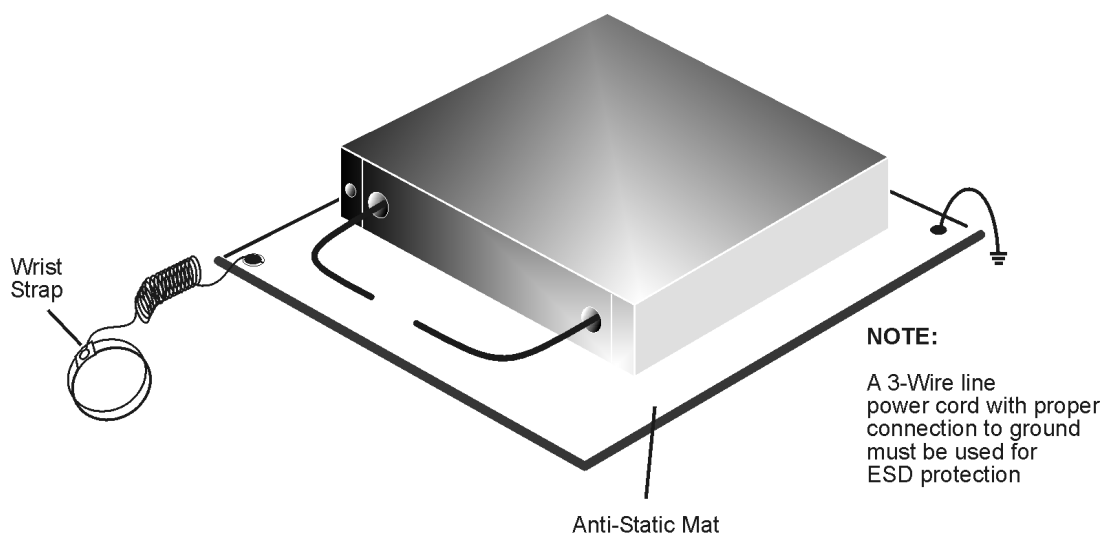
	The instruction documentation symbol. The product is marked with this symbol when it is necessary for the user to refer to the instructions in the documentation.
	This symbol indicates that the instrument requires alternating current (ac) input.
	This symbol indicates separate collection for electrical and electronic equipment, mandated under EU law as of August 13, 2005. All electric and electronic equipment are required to be separated from normal waste for disposal (Reference WEEE Directive, 2002/96/EC).
	This symbol indicates that the power line switch is ON.
	This symbol indicates that the power line switch is in the STANDBY position.
	This symbol indicates that the power line switch is in the OFF position.
	This symbol is used to identify a terminal which is internally connected to the product frame or chassis.
	The CE mark is a registered trademark of the European Community. (If accompanied by a year, it is when the design was proven.)
	The CSA mark is a registered trademark of the CSA International. This instrument complies with Canada: CSA 22.2 No. 61010-1-04.
	This is a symbol of an Industrial Scientific and Medical Group 1 Class A product.
	This is a marking to indicate product compliance with the Canadian Interference-Causing Equipment Standard (ICES-001).
	Direct Current.
	The instrument has been designed to meet the requirements of IP 2 0 for ingress and operational environment.
	This is a required mark signifying compliance with an EMC requirement. The C-Tick mark is a registered trademark of the Australian Spectrum Management Agency.
	China RoHS regulations include requirements related to packaging, and require compliance to China standard GB18455-2001.
	This symbol indicates compliance with the China RoHS regulations for paper/fiberboard packaging.

## Electrostatic Discharge Protection

Protection against electrostatic discharge (ESD) is essential while removing assemblies from or connecting cables to the network analyzer. Static electricity can build up on your body and can easily damage sensitive internal circuit elements when discharged. Static discharges too small to be felt can cause permanent damage. To prevent damage to the instrument:

- *always* have a grounded, conductive table mat (9300-0797) in front of your test equipment.
- *always* wear a grounded wrist strap (9300-1367) with grounding cord (9300-0980), connected to a grounded conductive table mat, having a 1 M $\Omega$  resistor in series with it, when handling components and assemblies or when making connections.
- *always* wear a heel strap (9300-1126) when working in an area with a conductive floor. If you are uncertain about the conductivity of your floor, wear a heel strap.
- *always* ground yourself before you clean, inspect, or make a connection to a static-sensitive device or test port. You can, for example, grasp the grounded outer shell of the test port or cable connector briefly.
- *always* ground the center conductor of a test cable before making a connection to the analyzer test port or other static-sensitive device. This can be done as follows:
  1. Connect a short (from your calibration kit) to one end of the cable to short the center conductor to the outer conductor.
  2. While wearing a grounded wrist strap, grasp the outer shell of the cable connector.
  3. Connect the other end of the cable to the test port and remove the short from the cable.

**Figure 16 ESD Protection Setup**



ku310b



---

## Contacting Agilent Sales and Service Offices

Assistance with test and measurement needs, and information on finding a local Agilent office are available on the Internet at:

*<http://www.agilent.com/find/assist>*

You can also purchase accessories or documentation items on the Internet at:

*<http://www.agilent.com/find>*

If you do not have access to the Internet, contact your field engineer.

---

**NOTE** In any correspondence or telephone conversation, refer to the product by its model number and full serial number. With this information, the Agilent representative can determine the warranty status of your unit.

---

